

# BRINOX

*Soluciones para el Hogar*



*Home Solutions*



**BR|NOX**

# BR|NOX

**BRINOX, S.A.**

Avda. Pau Casals, 136-138  
08907 L'Hospitalet de Llobregat  
Barcelona (Spain)

Tel. (+34) 93 336 18 12  
Fax (+34) 93 335 76 30  
email: [info@brinox.com](mailto:info@brinox.com)

BRINOX, S.A. © Febrero 2024



*Soluciones para el Hogar* *Home Solutions*

**BR|NOX**







Bienvenidos a BRINOX, S.A., un referente en la industria de fabricación y distribución de pequeños y medianos artículos de ferretería. Desde nuestra fundación en 1979, nos hemos destacado por mantener una posición de liderazgo gracias a nuestra dedicación a la calidad, la innovación y la satisfacción del cliente.

*Welcome to BRINOX, S.A., a leading company in the manufacturing and distribution of small and medium hardware articles. Since our establishment in 1979, we have been a benchmark in the industry, dedicated to quality, innovation, and customer satisfaction.*

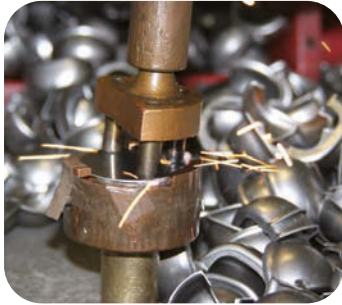

# BRINOX

## Nuestras señas de identidad

### **Materias primas de origen nacional**

Valoramos la calidad desde el inicio. Utilizamos materias primas de origen nacional para asegurar la excelencia en cada producto.

### **Fabricación propia**

Desde hace más de 40 años, somos fieles a nuestra esencia como fabricantes. Cada producto que sale de nuestras instalaciones refleja nuestro compromiso con la excelencia y la autenticidad.

### **Control de calidad personalizado**

Mantenemos rigurosos estándares de calidad en cada etapa del proceso de producción. Nuestro compromiso con la perfección garantiza productos duraderos y confiables.

### **Distribución ágil y moderna**

Con una red de distribución eficiente y moderna, aseguramos entregas oportunas para satisfacer las demandas de nuestros clientes en todo momento.

### **Compromiso familiar**

Conservamos nuestros valores familiares, lo que se traduce en relaciones cercanas y de confianza con nuestros clientes y empleados.

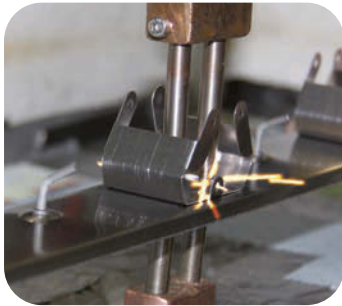

## *Our hallmarks*

### **Raw materials of national origin**

*We value quality from the outset. We use raw materials of national origin to ensure excellence in every product.*

### **In-house manufacturing**

*For over 40 years, we have remained true to our essence as manufacturers. Every product that leaves our facilities reflects our commitment to excellence and authenticity.*

### **Custom quality control**

*We maintain rigorous quality standards at every stage of the production process. Our dedication to perfection ensures durable and reliable products.*

### **Agile and modern distribution**

*With an efficient and modern distribution network, we ensure timely deliveries to meet our customers' demands at all times.*

### **Family commitment**

*We preserve our family values, translating into close and trustworthy relationships with our customers and employees.*



Soluciones para el Hogar Home Solutions

**BRINOX**

## Marcas BRINOX y BriKids

Bajo la marca Brinox, mantenemos nuestra posición como fabricantes, controlando minuciosamente cada aspecto de la producción. Cada diseño refleja nuestra dedicación a la calidad y la funcionalidad.

Comprometidos con la seguridad y la diversión, la marca BriKids ofrece soluciones innovadoras para los más pequeños, manteniendo los estándares de calidad que caracterizan a BRINOX.

### BRINOX and BriKids brands

*Under the Brinox brand, we maintain our position as manufacturers, meticulously controlling every aspect of production. Each design reflects our dedication to quality and functionality.*

*Committed to safety and fun, the BriKids brand offers innovative solutions for the little ones while maintaining the quality standards that characterize BRINOX.*

# BRINOX

# BRIKIDS®

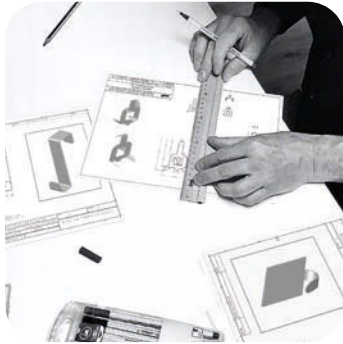

### Creatividad en el packaging

Nuestro packaging va más allá de ser simplemente funcional. Basado en dibujos explicativos, añade una dosis de creatividad que no solo atrae al consumidor, sino que también aumenta las posibilidades de venta.

Nos comprometemos a mejorar constantemente el rendimiento de la exposición, brindando productos que destacan en el mercado.

### Creativity in packaging

*We are committed to continually improving exhibition performance, providing products that stand out in the market. Our packaging goes beyond mere functionality. Based on explanatory drawings, it adds a dose of creativity that not only attracts the consumer but also increases the chances of a sale.*

*We are committed to continually improving exhibition performance, providing products that stand out in the market.*

### Confianza

Siguiendo esta metodología de trabajo exitosa durante más de 40 años nos ha llevado a obtener la confianza de más de 6000 clientes.

España, Andorra, Portugal, Francia, Alemania, Italia, Grecia, Suecia, Ecuador, México, Malta, Chipre, Suiza, Emiratos Árabes, Túnez, Inglaterra, Rusia, Uruguay, Bolivia, Sudáfrica y Senegal son algunos de los países que han apostado por nosotros.

### Trust

*Following this successful work methodology for over 40 years has earned us the trust of more than 6000 customers.*

*Spain, Andorra, Portugal, France, Germany, Italy, Greece, Sweden, Ecuador, Mexico, Malta, Cyprus, Switzerland, United Arab Emirates, Tunisia, England, Russia, Uruguay, Bolivia, South Africa, and Senegal. are some of the countries that have placed their trust in us.*



### Compromiso con el medio ambiente

En BRINOX, la integridad medioambiental es un pilar fundamental en nuestra filosofía de producción. Nuestros productos de madera están sometidos a un riguroso control de calidad que cumple estrictamente con la normativa vigente del Forest Stewardship Council (FSC). Abrazamos la responsabilidad ambiental, garantizando que la madera utilizada en nuestros productos no provenga de la deforestación.

### Commitment to the environment

*In BRINOX, environmental integrity is a fundamental cornerstone of our production philosophy. Our wooden products undergo rigorous quality control that strictly adheres to the current Forest Stewardship Council (FSC) regulations. We embrace environmental responsibility, ensuring that the wood used in our products does not come from deforestation.*

### Catálogo de productos

Presentamos con orgullo nuestro catálogo, con más de 1200 referencias cuidadosamente seleccionadas. Cada producto es una combinación de funcionalidad, diseño y calidad, diseñado para brindar beneficios tangibles en la exposición y la satisfacción del cliente.

### Product catalogue

*We proudly present our catalogue, with over 1200 carefully selected references. Each product is a blend of functionality, design, and quality, designed to provide tangible benefits in exhibition and customer satisfaction.*



# Índice

# Index



Percheros Madera <i>Wooden Hangers</i> .....	7
Perchas Grandes y Percheros Metálicos <i>Large Hooks and Metal Hangers</i> .....	11
Perchas Pequeñas y Colgadores <i>Small Hooks and Hangers</i> .....	23
Sujeta Escobas <i>Broom Hangers</i> .....	37
Topes para puerta <i>Door stops</i> .....	43
Retenedores para puertas y ventanas <i>Door and Window Retainers</i> .....	55
Protección Infantil <i>Children Safety</i> .....	61
Tapajuntas <i>Joint Covers</i> .....	65
Rejillas de Ventilación <i>Ventilation Grids</i> .....	83
Burlete para Puertas y Ventanas <i>Weatherstrips for Doors and Windows</i> .....	97
Canaleta Eléctrica <i>Cable Trunking</i> .....	107
Ángulos <i>Corner Guards</i> .....	111
Adhesivos y Selladores <i>Adhesives and Sealants</i> .....	117
Fieltros y Deslizadores <i>Felt and Sliders</i> .....	127
Antideslizantes <i>Non-Slippers</i> .....	141
Accesorios para Muebles <i>Furniture Accessories</i> .....	145
Bricolaje y accesorios para el hogar <i>DIY and Home Accessories</i> .....	153
Artículos de apoyo al Punto de Venta <i>Display stands</i> .....	171
Índice por Referencias <i>Index by Item No.</i> .....	174



**BR|NOX**

# Percheros de Madera

## Wooden Hangers

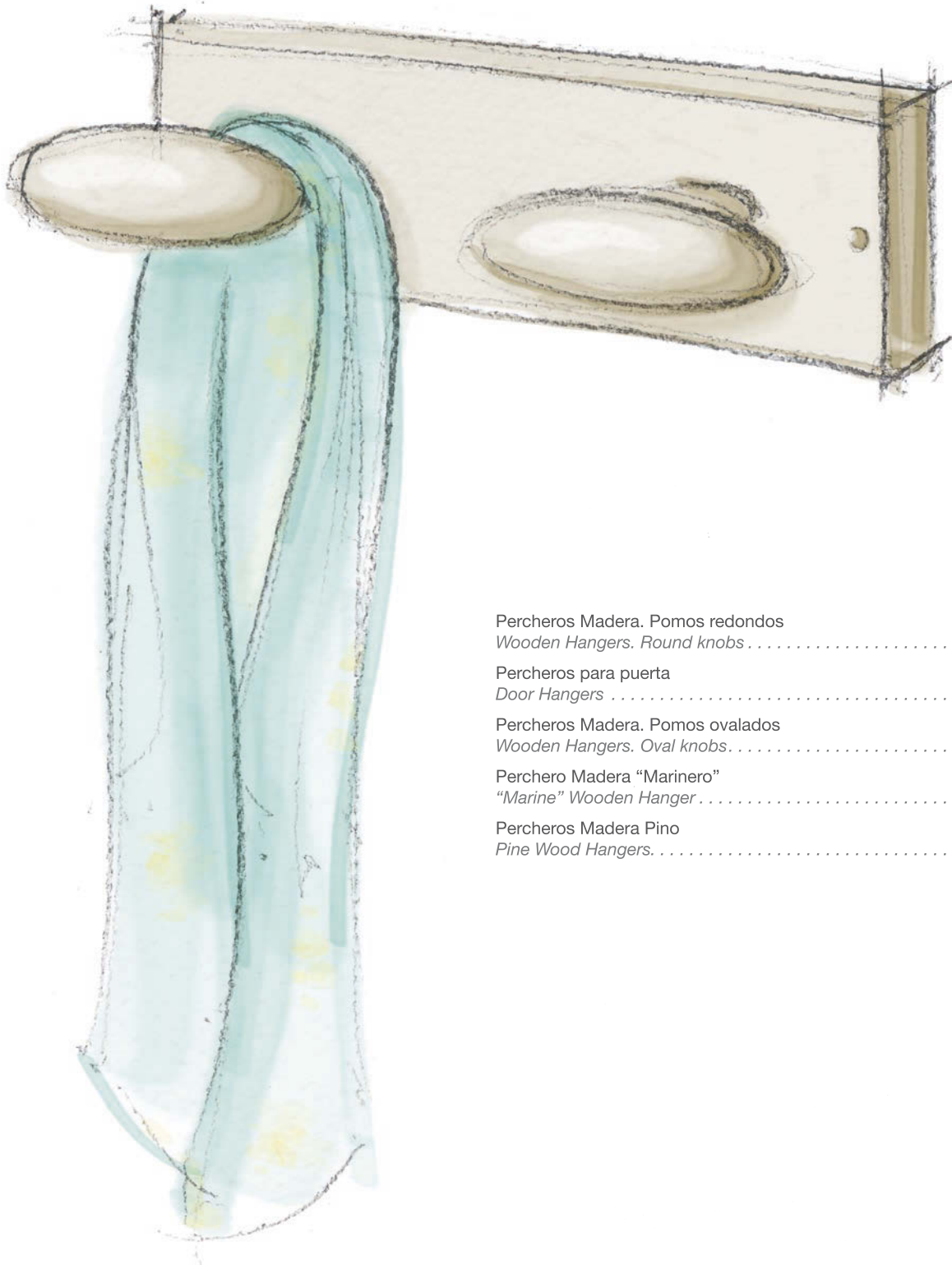

Percheros Madera. Pomos redondos <i>Wooden Hangers. Round knobs</i> .....	8
Percheros para puerta <i>Door Hangers</i> .....	9
Percheros Madera. Pomos ovalados <i>Wooden Hangers. Oval knobs</i> .....	9
Perchero Madera "Marinero" <i>"Marine" Wooden Hanger</i> .....	9
Percheros Madera Pino <i>Pine Wood Hangers</i> .....	10



**Percheros Madera. Pomos redondos**

Percheros de madera de Haya barnizada con tinte en color Roble, Sapeli y Lacado Blanco. Incluye tacos y tornillos para su colocación, y embellecedores para ocultar los tornillos.

**Wooden Hangers. Round knobs**

Hangers made varnished beech wood with oak, sapele and white lacquered stains. Includes plugs and screws for its placement, and screw cover caps to hide the screws.

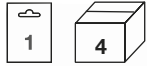
**Roble · Oak**

Ref.	Pomos Knobs	Tamaño Size	Código Barras Bar Code
B30200Y	3	355 x 55 mm	8421196110700
B30270Y	4	480 x 55 mm	8421196111158

**Lacado Blanco · White Lacquered**

Ref.	Pomos Knobs	Tamaño Size	Código Barras Bar Code
B30200D	3	355 x 55 mm	8421196112650
B30270D	4	480 x 55 mm	8421196112667

**Sapeli · Sapele**

Ref.	Pomos Knobs	Tamaño Size	Código Barras Bar Code
B30200Z	3	355 x 55 mm	8421196110717
B30270Z	4	480 x 55 mm	8421196111165

**Percheros para Puerta. Madera e Inox. 3 pomos**

Percheros de madera de Haya barnizada con tinte en color roble y sapeli. Incluye accesorio de montaje para puertas. No precisa agujerear la puerta para su colocación. Tamaño: 355 x 55 mm



**Door Hangers. Wood and Stainless Steel. 3 knobs**

Hangers made of varnished beech wood with oak and sapele stains. Includes mounting accessory for doors. It is not necessary to make holes in the door for its placement. Size: 355 x 55 mm

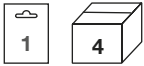

Ref.	Acabado Finish	Código Barras Bar Code
B31200Y	Roble Oak	8421196122079
B31200Z	Sapeli Sapele	8421196122086

**Percheros Madera. Pomos ovalados**

Percheros de madera de Haya barnizada con tinte en color Roble y Sapeli, con pomos de forma oval de madera maciza. Incluye tacos y tornillos para su colocación, y embellecedores para ocultar los tornillos.

**Wooden Hangers. Oval knobs**

Hangers made of varnished beech wood with oak and sapele stains, with oval-shaped knobs of solid wood. Includes plugs and screws for its placement, and screw cover caps to hide the screws.



**Roble · Oak**

Ref.	Pomos Knobs	Tamaño Size	Código Barras Bar Code
B30160Y	3	380 x 55 mm	8421196109377
B30260Y	4	485 x 55 mm	8421196111134



**Sapeli · Sapele**

Ref.	Pomos Knobs	Tamaño Size	Código Barras Bar Code
B30160Z	3	380 x 55 mm	8421196109384
B30260Z	4	485 x 55 mm	8421196111141



**Perchero Madera "Marinero". Color wengué**

Percheros de madera de haya barnizada con tinte Wengué con pomos metalizado mate. Incluye tacos y tornillos para su colocación, y embellecedores para ocultar los tornillos.

**"Marine" Wooden Hanger. Wenge colour**

Hanger made of varnished beech wood with wenge stain with matte metal knobs. Includes plugs and screws for its placement, and screw cover caps to hide the screws.



Ref.	Pomos Knobs	Tamaño Size	Código Barras Bar Code
B30430W	3	360 x 80 mm	8421196119536

**Percheros Madera Pino. Pomos redondos**

Percheros de madera de Pino barnizada con tinte en color Roble, Sapeli y Lacado Blanco. Los percheros de pino ofrecen una excelente relación calidad-precio. Incluye tacos y tornillos para su colocación, y embellecedores para ocultar los tornillos.

**Pine Wood Hangers. Round knobs**

Hangers made of varnished pine wood with oak, sapele and white lacquered stains. Pine wood hangers offer excellent value for money. Includes plugs and screws for its placement, and screw cover caps to hide the screws.

**Roble · Oak**

Ref.	Pomos Knobs	Tamaño Size	Código Barras Bar Code
B30300Y	2	220 x 55 mm	8421196112315
B30310Y	3	355 x 55 mm	8421196112346
B30320Y	4	480 x 55 mm	8421196112377

**Sapeli · Sapele**

Ref.	Pomos Knobs	Tamaño Size	Código Barras Bar Code
B30300Z	2	220 x 55 mm	8421196112322
B30310Z	3	355 x 55 mm	8421196112353
B30320Z	4	480 x 55 mm	8421196112384

**Lacado Blanco · White Lacquered**

Ref.	Pomos Knobs	Tamaño Size	Código Barras Bar Code
B30300D	2	220 x 55 mm	8421196112339
B30310D	3	355 x 55 mm	8421196112360
B30320D	4	480 x 55 mm	8421196112391



# Perchas Grandes y Percheros Metálicos

## Large Hooks and Metal Hangers



Percha Anzuelo Plástico <i>Cloth Hook "Fish-hook" Plastic</i> . . . . .	12
Percha Mini-Master Adhesiva Plástico <i>Cloth Hook "Mini-Master" Adhesive Plastic</i> . . . . .	12
Percha Master Adhesiva Plástico <i>Cloth Hook "Master" Adhesive Plastic</i> . . . . .	13
Percha Básica. Doble <i>"Basic" Cloth Hook. Double</i> . . . . .	14
Percha "Office". Individual <i>"Office" Wall Hook. Single</i> . . . . .	14
Percha "Office". Doble <i>"Office" Wall Hook. Double</i> . . . . .	14
Percha Baño. Ángulo <i>Bathroom Hook. Angle</i> . . . . .	15
Percha Baño. Recta <i>Bathroom Hook. Straight</i> . . . . .	15
Perchero Llave. 3 Ganchos <i>Key Hanger. 3 Hooks</i> . . . . .	15
Colgadores Cocina <i>Kitchen Hangers</i> . . . . .	16
Percheros Grandes <i>Large Wall Cloth Hangers</i> . . . . .	18
Percheros Metálicos para Puerta <i>Metallic Door Hangers</i> . . . . .	19
Perchas Grandes <i>Large Wall Cloth Hooks</i> . . . . .	19
Perchas y Percheros "Media Luna" <i>Half-moon Wall Hooks and Hangers</i> . . . . .	20
Percha Júnior <i>Junior Cloth Hook</i> . . . . .	21
Percha "Luxe" <i>"Luxe" Cloth Hook</i> . . . . .	21
Percha de Acero <i>Steel Cloth Hook</i> . . . . .	22
Soporte Puerta para Percheros <i>Door Mounting Accessory for Hangers</i> . . . . .	22
Percha para Cajones <i>Hanger for Drawers</i> . . . . .	22



**Percha "Anzuelo" Plástico**

Percha grande de plástico ABS en forma de anzuelo, con gancho superior e inferior. Incluye base con tornillos ocultos para su montaje.  
Tamaño: 30 x 100 mm

**Cloth Hook "Fish-hook" Plastic**

Large wall cloth hook made of ABS plastic with upper and lower hook. Includes base with hidden screws for its placement.

Size: 30 x 100 mm

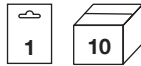

Ref.	Acabado Finish	Código Barras Bar Code
B52010B	Blanco White	8421196120129
B52010F	Cromado Mate Matt Chrome	8421196120150

**Percha "Mini-Master" Adhesiva Plástico**

Percha mediana de plástico ABS. Incluye adhesivo de alta calidad.  
Tamaño: 32 x 44 mm

**Cloth Hook "Mini-Master" Adhesive Plastic**

Medium wall cloth hook made of ABS plastic.

Includes high quality adhesive.

Size: 32 x 44 mm

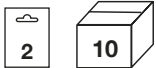

Ref.	Acabado Finish	Código Barras Bar Code
B52040B	Blanco White	8421196124639
B52040N	Negro Black	8421196125964
B52040Z	Madera Wood	8421196124691
B52040F	Cromado Mate Matt Chrome	8421196124653
B52040H	Transparente Transparent	8421196124660
B52040A	Amarillo transparente Yellow transparent	8421196124622
B52040C	Azul transparente Blue transparent	8421196124646
B52040R	Rojo transparente Red transparent	8421196124677
B52040V	Verde transparente Green transparent	8421196124684





**Percha "Master" Adhesiva Plástico**

Percha grande de plástico ABS.  
Incluye adhesivo de alta calidad.  
Tamaño: 44 x 60 mm

**Cloth Hook "Master" Adhesive Plastic**

Large wall cloth hook made of ABS plastic.  
Includes high quality adhesive.  
Size: 44 x 60 mm



Ref.	Acabado Finish	Código Barras Bar Code
B52030B	Blanco White	8421196122215
B52030N	Negro Black	8421196125957
B52030Z	Madera Wood	8421196122222
B52030F	Cromado Mate Matt Chrome	8421196122239
B52030H	Transparente Transparent	8421196122246
B52030A	Amarillo transparente Yellow transparent	8421196124585
B52030C	Azul transparente Blue transparent	8421196124592
B52030R	Rojo transparente Red transparent	8421196124608
B52030V	Verde transparente Green transparent	8421196124615



**Percha "Básica". Doble**

Percha grande de aluminio, con gancho superior e inferior.  
Incluye tacos y tornillos para su montaje.  
Tamaño: 19 x 100 mm

**"Basic" Cloth Hook. Double**

Large wall cloth hook made of aluminium with upper and lower hook.  
Includes plugs and screws for its placement.  
Size: 19 x 100 mm

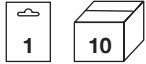

Ref.	Acabado Finish	Código Barras Bar Code
B72200F	Satinado Satin	8421196124813
B72200J	Cromado Chrome	8421196124820
B72200D	Lacado Blanco White Lacquered	8421196124806

**Percha "Office". Individual**

Percha mediana de zamak. Incluye tacos y tornillos para su montaje.  
Tamaño: 23 x 70 mm

**"Office" Wall Hook. Single**

Medium wall cloth hook made of zamak. Includes plugs and screws for its placement.  
Size: 23 x 70 mm

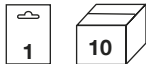

Ref.	Acabado Finish	Código Barras Bar Code
B72210F	Satinado Satin	8421196124738

**Percha "Office". Doble**

Percha mediana de zamak, con gancho superior e inferior.  
Incluye tacos y tornillos para su montaje.  
Tamaño: 23 x 145 mm

**"Office" Wall Hook. Double**

Medium wall cloth hook made of zamak with upper and lower hook.  
Includes plugs and screws for its placement.  
Size: 23 x 145 mm

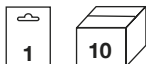

Ref.	Acabado Finish	Código Barras Bar Code
B72220F	Satinado Satin	8421196124721



### Percha Baño. Ángulo

Percha de baño fabricada en zamak con gancho en ángulo recto. Incluye tacos, tornillos y llave Allen para su montaje. Tamaño: Ø 60 x 71 mm

#### Bathroom Hook. Angle

Bathroom hanger made of zamak with a right-angle hook. Includes plugs, screws and Allen key for its assembly. Size: ø 60 x 71 mm



Ref.	Código Barras Bar Code
B72230E	8421196126152

### Percha Baño. Recta

Percha de baño recta fabricada en zamak. Incluye tacos, tornillos y llave Allen para su montaje. Tamaño: Ø 60 x 51 mm

#### Bathroom Hook. Straight

Straight bathroom hook made of zamak. Includes plugs, screws and Allen key for its assembly. Size: ø 60 x 51 mm



Ref.	Código Barras Bar Code
B72240E	8421196126169

### Perchero Llave. 3 Ganchos

Perchero en forma de llave con tres ganchos. Fabricado en zamak y acabado en acero antiguo. Incluye tacos y tornillos para su colocación. Tamaño: 222 x 73 mm

#### Key Hanger. 3 Hooks

Hanger in the shape of a key with three hooks. Made of zamak and finished in vintage steel. Includes plugs and screws for its placement. Size: 222 x 73 mm

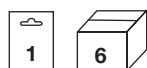

Ref.	Código Barras Bar Code
B72470E	8421196126138

**Colgadores Cocina**

Perchero con base de Acero Inoxidable de 0,6 mm de espesor.  
Incluye tacos y tornillos para su colocación.

**Kitchen Hangers**

Wall hangers with a 0.6 mm thick stainless steel base.  
Includes plugs and screws for its placement.

**4 Ganchos · 4 Hooks** (240 x 40 mm)

Ref.	Acabado Finish	Código Barras Bar Code
B70470E	Acero Inox Stainless steel	8421196101920
B70470D	Lacado Blanco White Lacquered	8421196101937

**5 Ganchos · 5 Hooks** (300 x 40 mm)

Ref.	Acabado Finish	Código Barras Bar Code
B70360E	Acero Inox Stainless steel	8421196101555
B70360D	Lacado Blanco White Lacquered	8421196101562
B70360Z	Madera Wood	8421196101579







**6 Ganchos • 6 Hooks** (350 x 40 mm)

Ref.	Acabado Finish	Código Barras Bar Code
B70480E	Acero Inox Stainless steel	8421196101968
B70480D	Lacado Blanco White Lacquered	8421196101975
B70480Z	Madera Wood	8421196101982





**Percheros Grandes**

Percheros con base de Acero Inoxidable o Acero Inoxidable Lacado de 0,6 mm, soporte de 1 mm de espesor y pomos en plástico ABS.  
Incluye tacos y tornillos para su colocación.

**Large Wall Cloth Hangers**

Wall cloth hangers with a 0.6 mm thick stainless steel or lacquered stainless steel base, a 1 mm thick holder and ABS plastic knobs.  
Includes plugs and screws for its placement.

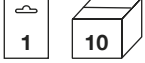
**2 Pomos · 2 Hooks (240 x 40 mm)**

Ref.	Acabado Finish	Código Barras Bar Code
B70450D	Lacado Blanco White Lacquered	8421196101821
B70450J	Cromado Chrome	8421196101845

**3 Pomos · 3 Hooks (350 x 40 mm)**

Ref.	Acabado Finish	Código Barras Bar Code
B70460D	Lacado Blanco White Lacquered	8421196101890
B70460J	Cromado Chrome	8421196101913
B70460M	Porcelana Porcelain	8421196101906



**Percheros Metálicos para Puerta**

Percheros con base de Acero Inoxidable y 3 pomos en plástico ABS. Incluye accesorio de montaje para puertas. No precisa agujerear la puerta para su colocación. Tamaño: 350 x 40 mm



Ref.	Acabado Finish	Código Barras Bar Code
B32460D	Lacado Blanco White Lacquered	8421196122147
B32460J	Cromado Chrome	8421196122154

**Metallic Door Hangers**

Wall cloth hagers with stainless steel base and 3 ABS plastic knobs. Includes mounting accessory for the door. It is not necessary to make holes in the door for its placement. Size: 350 x 40 mm



**Perchas Grandes**

Perchas con base de Acero Inoxidable o Acero Inoxidable Lacado de 1 mm de espesor y pomo en plástico ABS. Adhesivo de alta calidad. Orificio para colocación con tornillo en superficies porosas o con poca adherencia. Tamaño: 42 x 50 mm

**Large Wall Cloth Hooks**

Wall cloth hooks with a 1 mm thick stainless steel base and ABS plastic knob. High quality adhesive. Hole for screw fixing on porous or low-adhering surfaces. Size: 42 x 50 mm

Ref.	📦	📦	Acabado Finish	Código Barras Bar Code
B70440B	2	20	Blanco White	8421196101708
B70440N			Lacado Negro Black Lacquered	8421196101715
B70440Z			Madera Wood	8421196101722
B70440D			Lacado Blanco White Lacquered	8421196101753
B70440M			Porcelana Porcelain	8421196101777
B70440J			Cromado Chrome	8421196101760
B70440F			Cromado Mate Matt Chrome	8421196119208
B70441B	1	10	Blanco White	8421196119154
B70441N			Lacado Negro Black Lacquered	8421196125988
B70441Z			Madera Wood	8421196119192
B70441D			Lacado Blanco White Lacquered	8421196119161
B70441M			Porcelana Porcelain	8421196119185
B70441J			Cromado Chrome	8421196119178
B70441F			Cromado Mate Matt Chrome	8421196115811





**Perchas y Percheros “Media Luna”**

Perchas y Percheros con base de Acero Inoxidable de 1 mm de espesor. Pomos en plástico ABS con forma de media luna especialmente diseñados para evitar desperfectos en la ropa. Incluye tacos y tornillos para su colocación.



**“Half-moon” Wall Hooks and Hangers**

Wall hooks and hangers with a 1mm thick stainless steel base. ABS plastic knobs in a shape of half-moon specially designed to avoid damage to clothes. Includes plugs and screws for its placement.



**1 Pomo · 1 Knob** (45 x 84 mm)

Ref.	Acabado Finish	Código Barras Bar Code	1	10
B72420B	Blanco White	8421196115859		
B72420D	Lacado Blanco White Lacquered	8421196115866		
B72420F	Cromado Mate Matt Chrome	8421196115873		

**2 Pomos · 2 Knobs** (280 x 50 mm)

Ref.	Acabado Finish	Código Barras Bar Code	1	6
B72430D	Lacado Blanco White Lacquered	8421196116061		
B72430F	Cromado Mate Matt Chrome	8421196116078		

**3 Pomos · 3 Knobs** (420 x 50 mm)

Ref.	Acabado Finish	Código Barras Bar Code	1	6
B72440D	Lacado Blanco White Lacquered	8421196116092		
B72440F	Cromado Mate Matt Chrome	8421196116108		



**Perchas Júnior**

Perchas con base de Acero Inoxidable o Acero Inoxidable Lacado de 1 mm de espesor y pomo en plástico ABS. Adhesivo de alta calidad. Orificio para colocación con tornillo en superficies porosas o con poca adherencia. Tamaño: 30 x 45 mm

**Junior Cloth Hooks**

Wall cloth hooks with a 1 mm thick stainless steel base and ABS plastic knob. High quality adhesive. Hole for screw fixing on porous or low-adhering surfaces. Size: 30 x 45 mm

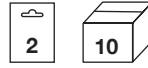

Ref.	Acabado Finish	Código Barras Bar Code
B70430B	Blanco White	8421196104532
B70430D	Lacado Blanco White Lacquered	8421196104488
B70430J	Cromado Chrome	8421196104471
B70430M	Porcelana Porcelain	8421196104495
B70430F	Cromado Mate Matt Chrome	8421196116016



**Perchas "Luxe"**

Perchas con base de Acero Inoxidable Lacado de 1 mm de espesor y pomo en plástico ABS. Adhesivo de alta calidad. Orificio para colocación con tornillo en superficies porosas o con poca adherencia. Tamaño: 45 x 60 mm

**"Luxe" Cloth Hooks**

Wall cloth hooks with a 1 mm thick lacquered stainless steel base and ABS plastic knob. High quality adhesive. Hole for screw fixing on porous or low-adhering surfaces. Size: 45 x 60 mm



Ref.	Acabado Finish	Código Barras Bar Code
B70670D	Lacado Blanco White Lacquered	8421196102804
B70670M	Porcelana Porcelain	8421196102811



**Perchas de Acero**

Perchas de Acero Inoxidable de 1 mm de espesor con pomo en forma curvada especialmente diseñado para evitar roces y desperfectos en la ropa. Adhesivo de alta calidad. Orificio para colocación con tornillo en superficies porosas o con poca adherencia. Tamaño: 40 x 55 mm

**Steel Cloth Hooks**

Wall cloth hooks made of 1 mm-thick stainless steel with a knob in a curved shape specially designed to avoid damage to clothes. High quality adhesive. Hole for screw fixing on porous or low-adhering surfaces.

Size: 40 x 55 mm



Ref.	Acabado Finish	Código Barras Bar Code
B72410D	Lacado Blanco White Lacquered	8421196111172
B72410M	Porcelana Porcelain	8421196111189
B72410F	Cromado Mate Matt Chrome	8421196119949

**Soporte Puerta para Percheros**

Accesorio para convertir cualquier percha o perchero en un perchero para puerta. Incluye tornillos para montar el perchero. No precisa agujerear la puerta para su colocación.

**Door Mounting Accessory for Hangers**

Accessory to transform any hook or hanger into a door hanger. Includes screws for mounting the hanger. It is not necessary to make holes in the door for its placement.



Ref.	Tamaño Size	Acabado Finish	Código Barras Bar Code
B31000E	55 x 150 mm	Acero Inoxidable Stainless Steel	8421196121997

**Percha para Cajones**

Percha de Acero Inoxidable de 1 mm de espesor con protector de fieltro interior para evitar roces y desperfectos en el mueble.

Soporte para puertas de armarios y cajones de hasta 19 mm.

Tamaño: 16 x 75 mm

**Hook for Drawers**

Hook made of 1 mm-thick stainless steel with an inner felt protector to prevent damage to the furniture.

Suitable for cabinet doors and drawers up to 19 mm.

Size: 16 x 75 mm



Ref.	Acabado Finish	Código Barras Bar Code
B31010D	Lacado Blanco White Lacquered	8421196124745
B31010E	Acero Inox Stainless steel	8421196124752



# Perchas Pequeñas y Colgadores

## Small Hooks and Hangers

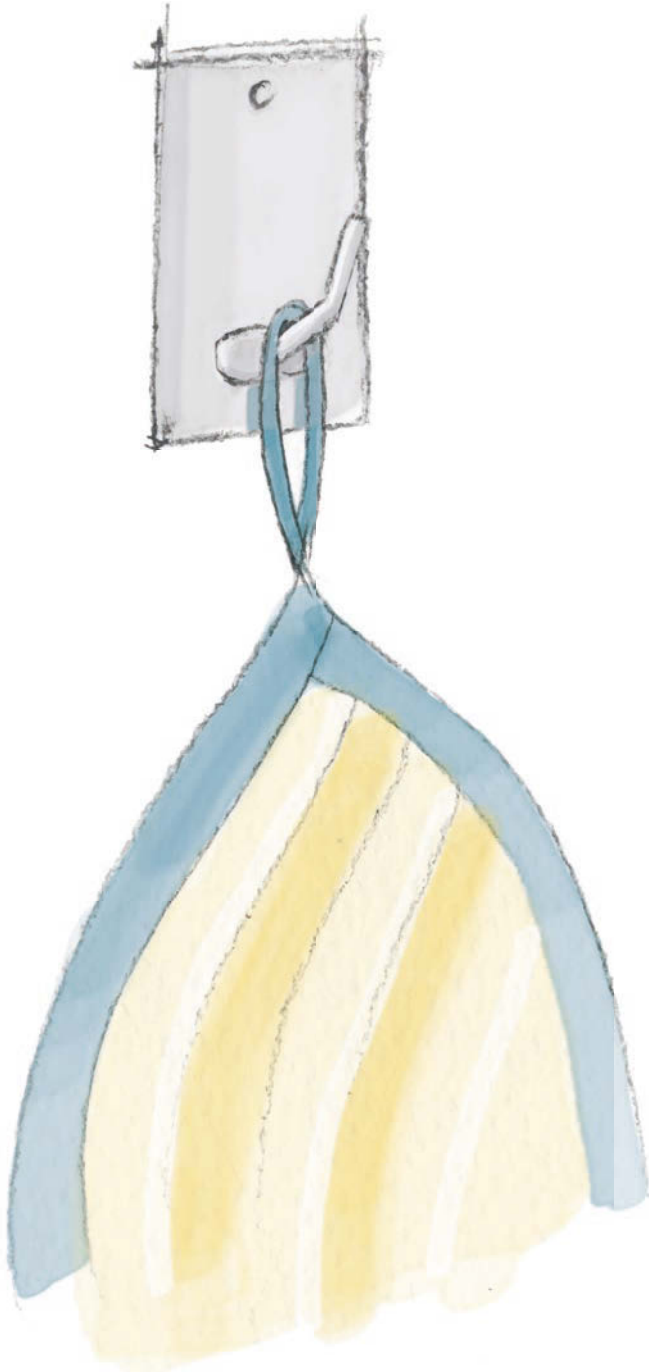

Mini Percha Adhesiva <i>Mini Wall Hook. Adhesive</i> .....	24
Percha Pequeña Adhesiva <i>Small Wall Hook. Adhesive</i> .....	24
Colgador Gancho Largo Adhesivo <i>Long Wall Hook. Adhesive</i> .....	24
Percha Mediana Adhesiva <i>Medium Wall Hook. Adhesive</i> .....	25
Percha Gancho Grande Adhesiva <i>Large Wall Hook. Adhesive</i> .....	25
Perchas Diseño "Poker" Adhesivas <i>Poker Wall Hook. Adhesive</i> .....	26
Perchas Cuadradas <i>Square Wall Hooks</i> .....	27
Mini Percha adhesiva. Plástico <i>Mini Wall Hook Adhesive. Plastic</i> .....	28
Percha Baño adhesiva Plástico <i>Large Bathroom Plastic Wal Hook. Adhesive</i> .....	28
Percha adhesiva. Plástico <i>Wall Hook. Plastic</i> .....	28
Colgador tres brazos adhesivo. Plástico <i>3 hooks Wall Hanger. Plastic</i> .....	28
Percha Mediana Plástico Adhesiva <i>Medium Plastic Wall Hook. Adhesive</i> .....	29
Percha Pequeña Plástico Adhesiva <i>Small Plastic Wall Hook. Adhesive</i> .....	29
Percha "Escudo" Plástico Adhesiva <i>"Shield" Plastic Wall Hook. Adhesive</i> .....	29
Perchas de Visillos <i>Curtain Rod Hooks</i> .....	30
Sujeta Trapos <i>Kitchen Towel Hanger</i> .....	31
Soporte Multiusos con Clavos <i>Multi-uses Wall Hook with Nails</i> .....	32
Soportes Cuelga cuadros <i>Supports for hanging pictures</i> .....	33
Colgadores de ventosa <i>Suction cups</i> .....	34
Ventosa Doble Cara <i>Double side suction cup</i> .....	34
Colgador Articulado de Ventosa <i>Suction Hook. Articulated</i> .....	35
Perchas removibles <i>Removal Hangers</i> .....	35
Percha Plástico Hexagonal Adhesiva <i>Plastic Hexagon Wall Hook. Adhesive</i> .....	36
Percha "Colmillo" Adhesiva <i>"Tusk" Hook. Adhesive</i> .....	36
Soporte para Tapones <i>Sink Stopper Holder</i> .....	36

**Mini Percha Adhesiva**

Percha con base de Acero Inoxidable de 0,8 mm de espesor. Adhesivo de alta calidad. Orificio para agarre con tornillo en superficies porosas o con poca adherencia. Tamaño: 17 x 26 mm

**Mini Wall Hook. Adhesive**

Wall hook with a stainless steel thickness 0.8 mm. High quality adhesive. Hole to fix a screw on a porous or little adherence surface. Size: 17 x 26 mm



Ref.	Acabado Finish	Código Barras Bar Code
B70270E	Acero Inox Stainless steel	8421196101463
B70270D	Lacado Blanco White Lacquered	8421196105539
B70270F	Cromado Mate Matt Chrome	8421196119932

**Percha Pequeña Adhesiva**

Percha con base de Acero Inoxidable de 0,8 mm de espesor. Adhesivo de alta calidad. Orificio para agarre con tornillo en superficies porosas o con poca adherencia. Tamaño: 20 x 30 mm

**Small Wall Hook. Adhesive**

Wall hook with a stainless steel thickness 0.8 mm. High quality adhesive. Hole to fix a screw on a porous or little adherence surface. Size: 20 x 30 mm

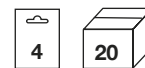

Ref.	Acabado Finish	Código Barras Bar Code
B70250E	Acero Inox Stainless steel	8421196101395
B70250D	Lacado Blanco White Lacquered	8421196105591

**Colgador Gancho Largo Adhesivo**

Colgador con base de Acero Inoxidable de 0,8 mm de espesor. Adhesivo de alta calidad. Orificio para agarre con tornillo en superficies porosas o con poca adherencia. Tamaño: 23 x 40 mm

**Long Wall Hook. Adhesive**

Adhesive wall hook with a stainless steel 0.8 mm thickness base. High quality adhesive. Hole to fix a screw on a porous or little adherence surface. Size: 23 x 40 mm



Ref.	Acabado Finish	Código Barras Bar Code
B70180E	Acero Inox Stainless steel	8421196100978
B70180D	Lacado Blanco White Lacquered	8421196105065



**Percha Mediana Adhesiva**

Percha con base de Acero Inoxidable o Acero lacado de 0,8 mm de espesor. Adhesivo de alta calidad. Orificio para agarre con tornillo en superficies porosas o con poca adherencia. Tamaño: 26 x 43 mm

**Medium Wall Hook. Adhesive**

Wall hook with a base in stainless steel or lacquered steel thickness 0.8 mm. High quality adhesive. Hole to fix a screw on porous or little adherence surface. Size: 26 x 43 mm

Ref.	Acabado Finish	Código Barras Bar Code
B70260E	Acero Inox Stainless steel	8421196101401
B70260Z	Madera Wood	8421196101418
B70260D	Lacado Blanco White Lacquered	8421196101425
B70260M	Porcelana Porcelain	8421196101456
B70260F	Cromado Mate Matt Chrome	8421196117709

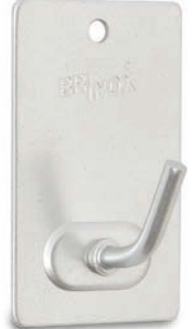
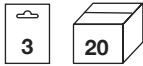

**Percha Gancho Grande Adhesiva**

Percha con base de Acero Inoxidable o Acero lacado de 0,8 mm de espesor. Adhesivo de alta calidad. Orificio para agarre con tornillo en superficies porosas o con poca adherencia. Tamaño: 36 x 53 mm

**Large Wall Hook. Adhesive**

Wall hook with a base in stainless steel or lacquered steel thickness 0.8 mm. High quality adhesive. Hole to fix a screw on a porous or little adherence surface. Size: 36 x 53 mm



Ref.	Acabado Finish	Código Barras Bar Code
B72010E	Acero Inox Stainless steel	8421196110519
B72010D	Lacado Blanco White Lacquered	8421196110526
B72010M	Porcelana Porcelain	8421196110540
B72010F	Cromado Mate Matt Chrome	8421196116023



**Perchas Diseño "Poker". Adhесivas**

Percha con base de Acero Inoxidable de 0,8 mm de espesor.  
Diseños baraja francesa. Adhesivo de alta calidad.  
Tamaño: 52 x 44 mm

**Poker Wall Hook. Adhesive**

Adhesive wall hook with a stainless steel 0.8 mm thickness base.  
Design inspired by the playing card symbols. High quality  
adhesive. Size: 44 x 52 mm

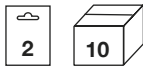

Picas · Spades		
Ref.	Acabado Finish	Código Barras Bar Code
B72110E	Acero Inox Stainless steel	8421196112100
B72110D	Lacado Blanco White Lacquered	8421196112094



Trébol · Clubs		
Ref.	Acabado Finish	Código Barras Bar Code
B72130E	Acero Inox Stainless steel	8421196112186
B72130D	Lacado Blanco White Lacquered	8421196112179

**Corazones · Hearts**

Ref.	Acabado Finish	Código Barras Bar Code
B72120E	Acero Inox Stainless steel	8421196112148
B72120D	Lacado Blanco White Lacquered	8421196112131



Rombo · Diamonds		
Ref.	Acabado Finish	Código Barras Bar Code
B72140E	Acero Inox Stainless steel	8421196112223
B72140D	Lacado Blanco White Lacquered	8421196112216



**Percha Cuadrada Mediana**

Percha con base de Acero Inoxidable de 0,8 mm de espesor. Adhesivo de alta calidad. Tamaño: 30 x 30 mm

**Medium Square Wall Hook**

Wall hook with a stainless steel 0.8 mm thickness base. High quality adhesive. Size: 30 x 30 mm

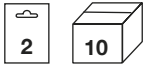

Ref.	Acabado Finish	Código Barras Bar Code
B72060E	Acero Inox Stainless steel	8421196124776
B72060D	Lacado Blanco White Lacquered	8421196124769

**Percha Cuadrada Grande**

Percha con base de Acero Inoxidable de 1 mm de espesor. Adhesivo de alta calidad. Tamaño: 45 x 45 mm

**Large Square Wall Hook**

Wall hook with a stainless steel 1 mm thickness base. High quality adhesive. Size: 45 x 45 mm



Ref.	📦	📦	Acabado Finish	Código Barras Bar Code
B72070E	2	10	Acero Inox Stainless Steel	8421196124790
B72070D			Lacado Blanco White Lacquered	8421196124783
B72071E	1	10	Acero Inox Stainless Steel	8421196125186
B72071D			Lacado Blanco White Lacquered	8421196125179



**Mini Percha adhesiva. Plástico**

Mini Percha de plástico ABS. Adhesivo de alta calidad.  
Tamaño: 20 x 28 mm

**Mini Wall Hook Adhesive. Plastic**

Mini wall ABS plastic hook. High quality adhesive.  
Size: 20 x 28 mm



Ref.	Color Colour	Código Barras Bar Code
B50080B	Blanco White	8421196104419

**Percha Baño adhesiva Plástico**

Percha grande de plástico ABS.  
Adhesivo de alta calidad. Orificios para agarre con tornillo en superficies porosas o con poca adherencia.  
Tamaño: 45 x 40 mm

**Large Bathroom Plastic Wall Hook. Adhesive**

Large adhesive ABS Bathroom plastic wall hook. High quality adhesive. Hole to fix a screw on a porous or little adherence surface.  
Size: 45 x 40 mm



Ref.	Color Colour	Código Barras Bar Code
B50030B	Blanco White	8421196100145

**Percha adhesiva. Plástico**

Percha de plástico ABS. Adhesivo de alta calidad.  
Tamaño: 35 x 40 mm

**Wall Hook. Plastic**

ABS plastic wall hook. High quality adhesive.  
Size: 35 x 40 mm

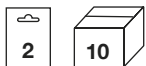

Ref.	Color Colour	Código Barras Bar Code
B50010B	Blanco White	8421196100060

**Colgador tres brazos adhesivo. Plástico**

Colgador 3 brazos de plástico ABS.  
Adhesivo de alta calidad.  
Tamaño: 175 x 40 mm

**3 hooks Wall Hanger. Plastic**

ABS plastic 3 hooks wall hanger.  
High quality adhesive.  
Size: 175 x 40 mm

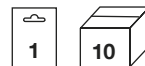

Ref.	Color Colour	Código Barras Bar Code
B50020B	Blanco White	8421196100107

**Percha Mediana Plástico Adhesiva**

Percha de plástico ABS. Adhesivo de alta calidad.  
Tamaño mediano: 33 x 46 mm

**Medium Plastic Wall Hook. Adhesive**

ABS plastic wall hook. High quality adhesive.  
Medium size: 33 x 46 mm

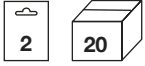

Ref.	Acabado Finish	Código Barras Bar Code
B50180B	Blanco White	8421196109438
B50180Z	Madera Wood	8421196109445
B50180M	Cerámico Marrón Brown ceramic	8421196109476



**Percha Pequeña Plástico Adhesiva**

Percha de plástico ABS. Adhesivo de alta calidad.  
Tamaño pequeño: 22 x 32 mm

**Small Plastic Wall Hook. Adhesive**

ABS plastic wall hook. High quality adhesive.  
Small Size: 22 x 32 mm



Ref.	Acabado Finish	Código Barras Bar Code
B50190B	Blanco White	8421196109520
B50190Z	Madera Wood	8421196109537
B50190M	Cerámico Marrón Brown ceramic	8421196109568



**Percha "Escudo" Plástico Adhesiva**

Percha con forma de escudo en plástico ABS. Adhesivo de alta calidad.  
Tamaño: 34 x 48 mm

**"Shield" Plastic Wall Hook. Adhesive**

ABS plastic wall hook with a Shield shape. High quality adhesive.  
Size: 34 x 48 mm



Ref.	Acabado Finish	Código Barras Bar Code
B50200B	Blanco White	8421196113701
B50200Z	Madera Wood	8421196113718



**Percha Visillo Mediana Adhesiva**

Percha de plástico PVC con varilla incrustada de Acero Inoxidable.  
Diseñada para el soporte de barras de visillos. Adhesivo de alta calidad.  
Tamaño: 19 x 27 mm

**Medium Curtain Rod Hook. Adhesive**

Adhesive PVC plastic curtain rod hook. Stainless steel inlaid stalk.  
Designed to hold a medium curtain rod. High quality adhesive.  
Size: 19 x 27 mm



Ref.	Acabado Finish	Código Barras Bar Code
B50170B	Blanco White	8421196108035

**Percha Visillo Pequeña Adhesiva**

Percha de plástico PVC con varilla incrustada de Acero Inoxidable.  
Diseñada para el soporte de barras de visillos.  
Adhesivo de alta calidad. Tamaño: 17 x 25 mm

**Small Curtain Rod Hook. Adhesive**

Adhesive PVC plastic curtain rod hook. Stainless steel inlaid stalk.  
Designed to hold a small curtain rod. High quality adhesive.  
Size: 17 x 25 mm



Ref.	Acabado Finish	Código Barras Bar Code
B50060B	Blanco White	8421196100244
B50060Z	Madera Wood	8421196100275
B50060K	Oro Gold	8421196100282
B50060P	Plata Silver	8421196100299
B50060H	Transparente Transparent	8421196122253



Ref.	Acabado Finish	Código Barras Bar Code
B50040B	Blanco White	8421196100183
B50040F	Cromado Mate Matt Chrome	8421196115750



### Sujeta Trapos a Presión

Sujeta trapos con base de plástico ABS, embellecedor cromado y aletas de presión de goma. Adhesivo de alta calidad. Orificios internos para su colocación con tacos y tornillos. Tamaño: 61 x 61 mm

### Kitchen Towel Hanger

Kitchen towel holder with an ABS plastic base. Chrome frame and rubber pressure wings. High quality adhesive. Internal hole for fixing with screws and plugs. Size: 61 x 61 mm

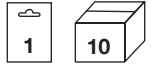

### Sujeta Trapos Triple a Presión

Sujeta trapos triple con base de plástico ABS, embellecedor cromado y aletas de presión de goma. Adhesivo de alta calidad. Orificios internos para su colocación con tacos y tornillos. Tamaño: 190 x 61 mm

### Triple Kitchen Towel Hanger

Triple kitchen towel hanger with an ABS plastic base. Chrome frame and rubber pressure wings. High quality adhesive. Internal hole for a fixing with screws and plugs. Size: 190 x 61 mm



Ref.	Acabado Finish	Código Barras Bar Code
B50050B	Blanco White	8421196100213
B50050F	Cromado Mate Matt Chrome	8421196115767



**Soporte Multiusos con 1 Clavo**

Gancho en plástico PVC, con 1 clavo de punta templada.  
Incluye soporte aplicador para evitar golpes en los dedos.  
Tamaño: Ø 11 mm

**Multi-uses Wall Hook. 1 Nail**

PVC plastic wall hook with 1 tempered point nail.  
It includes an applicator to avoid injuries.  
Size: Ø 11 mm



Ref.	Acabado Finish	Código Barras Bar Code
B50630H	Transparente Transparent	8421196115668

**Soporte Multiusos con 2 Clavos**

Gancho en plástico PVC, con 2 clavos de punta templada.  
Tamaño: 11 x 30 mm

**Multi-uses Wall Hook. 2 Nails**

PVC plastic wall hook with 2 tempered point nails.  
Size: 11 x 30 mm



Ref.	Acabado Finish	Código Barras Bar Code
B50640H	Transparente Transparent	8421196120112

**Soporte Multiusos con 3 Clavos**

Gancho en plástico PVC, con 3 clavos de punta templada.  
Tamaño: 14 x 31 mm

**Multi-uses Wall Hook. 3 Nails**

PVC plastic wall hook with 3 tempered point nails.  
Size: 14 x 31 mm



Ref.	Acabado Finish	Código Barras Bar Code
B50650H	Transparente Transparent	8421196115675





**Gancho cuelga cuadros**

Gancho para colgar cuadros a la pared.  
Modelo patentado que consta de 3 puntas que aseguran un perfecto anclaje.  
Dimensiones: 14 x 20 mm



**Picture wall hanger**

Patented hanger with 3 hooks, specially designed for a better adhesion to the wall.  
Size: 14 x 20 mm

**8 Ganchos cuelga cuadros  
8 Picture wall hanger**

Ref.	Código Barras Bar Code
B50670B	8421196124530



**Soporte cuelga cuadros**

Soporte para marcos de cuadros de madera.  
3 posiciones de colocación para corregir la inclinación.  
Incluye clavos para su montaje.  
Dimensiones: 43 x 8 mm

**Frame Support for Hanging Pictures**

Support for wood picture frames.  
3 position to correct the inclination.  
Include nails for mount.  
Size: 43 x 8 mm



**8 Soportes cuelga cuadros  
8 Support for Pictures**

Ref.	Código Barras Bar Code
B50680C	8421196124554

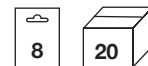

**4 Ganchos + 4 Soportes Cuelga cuadros  
4 Wall hangers + 4 Support for Pictures**

Ref.	Código Barras Bar Code
B50690B	8421196124578

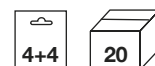

**Colgador de ventosa con gancho de acero**

Ventosa fabricada en plástico de PVC, con gancho de Acero cromado.

**Suction cup with metal hook**

Plastic PVC suction cup with Chrome metal hook.



Ref.		Tamaño Size	Código Barras Bar Code
B50800H	2	Ø 30 mm	8421196122963
B50810H	2	Ø 40 mm	8421196122987
B50820H	2	Ø 50 mm	8421196123007
B50830H	1	Ø 80 mm	8421196123021

**Colgador de ventosa con gancho de plástico**

Ventosa fabricada en plástico de PVC con gancho de plástico rígido de PVC.

**Suction cup with plastic hook**

Plastic PVC suction cup with rigid PVC plastic hook.



Ref.	Tamaño Size	Código Barras Bar Code
B50900H	Ø 30 mm	8421196123045
B50910H	Ø 40 mm	8421196123069
B50920H	Ø 50 mm	8421196123083

**Ventosa Doble Cara**

Ventosa de doble cara fabricada en plástico de PVC.

**Double side suction cup**

Plastic PVC double side suction cup.

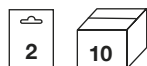

Ref.	Tamaño Size	Código Barras Bar Code
B50950H	Ø 30 mm	8421196123106



**Colgador Articulado de Ventosa**

Colgador de plástico ABS con gancho articulado para aplicar presión a la ventosa de goma.



Ref.		Tamaño Size	Código Barras Bar Code
B50510B	2	Pequeño / Small Ø 44 mm	8421196115163
B50520B	2	Mediano / Medium Ø 53 mm	8421196115187
B50530B	1	Grande / Large Ø 78 mm	8421196115200

**Suction Hook. Articulated**

ABS plastic hook. The articulation allows to apply pressure to the rubber suction cup.

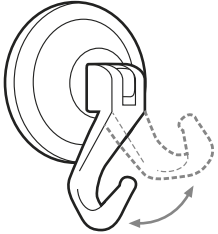

**Perchas removibles**

Perchas de plástico Transparente con base de silicona removible de gran poder de absorción. No deja residuos y es reutilizable.

**Removal Hangers**

Transparent plastic Hanger with removal silicone base with great absorption power.

Doesn't leaves residues and is reusable.



Ref.	Tamaño Size	Código Barras Bar Code
B51000H	48 x 61 mm	8421196122642

Ref.	Tamaño Size	Código Barras Bar Code
B51010H	62 x 80 mm	8421196122666





**Percha Plástico Hexagonal Adhesiva**

Percha de plástico ABS. Adhesivo de alta calidad.  
Tamaño: 44 x 49 mm

**Plastic Hexagon Wall Hook Adhesive**

Adhesive ABS plastic wall hook. High quality adhesive.  
Size: 44 x 49 mm



Ref.	Acabado Finish	Código Barras Bar Code
B50210B	Blanco White	8421196117785
B50210Z	Madera Wood	8421196117792
B50210F	Cromado Mate Matt Chrome	8421196117839
B50210H	Transparente Transparent	8421196122185

**Percha "Colmillo" Adhesiva**

Percha con base de Acero Inoxidable de 0,8 mm de espesor. Gancho en forma de colmillo en plástico ABS. Adhesivo de alta calidad. Orificio para agarre con tornillo en superficies porosas o con poca adherencia.  
Tamaño: 30 x 50 mm

**"Tusk" Hook. Adhesive**

Adhesive wall hook with a stainless steel 0.8 mm thickness base. ABS plastic hook with a tusk shape. Hole to fix a screw on a porous or little adherence surface.  
Size: 30 x 50 mm



Ref.	Acabado Finish	Código Barras Bar Code
B70150D	Lacado Blanco White Lacquered	8421196104433
B70150F	Cromado Mate Matt Chrome	8421196116030

**Soporte para Tapones**

Soporte para tapones fabricado en plástico ABS.  
Orificios en la base para desaguar. Adhesivo de alta calidad.  
Tamaño: Ø 66 x 27 mm

**Sink Stopper Holder**

ABS plastic sink stopper holder. Little hole on the base to drain.  
High quality adhesive. Size: Ø 66 x 27 mm



Ref.	Acabado Finish	Código Barras Bar Code
B50400B	Blanco White	8421196115033



# Sujeta Escobas

## Broom Hangers

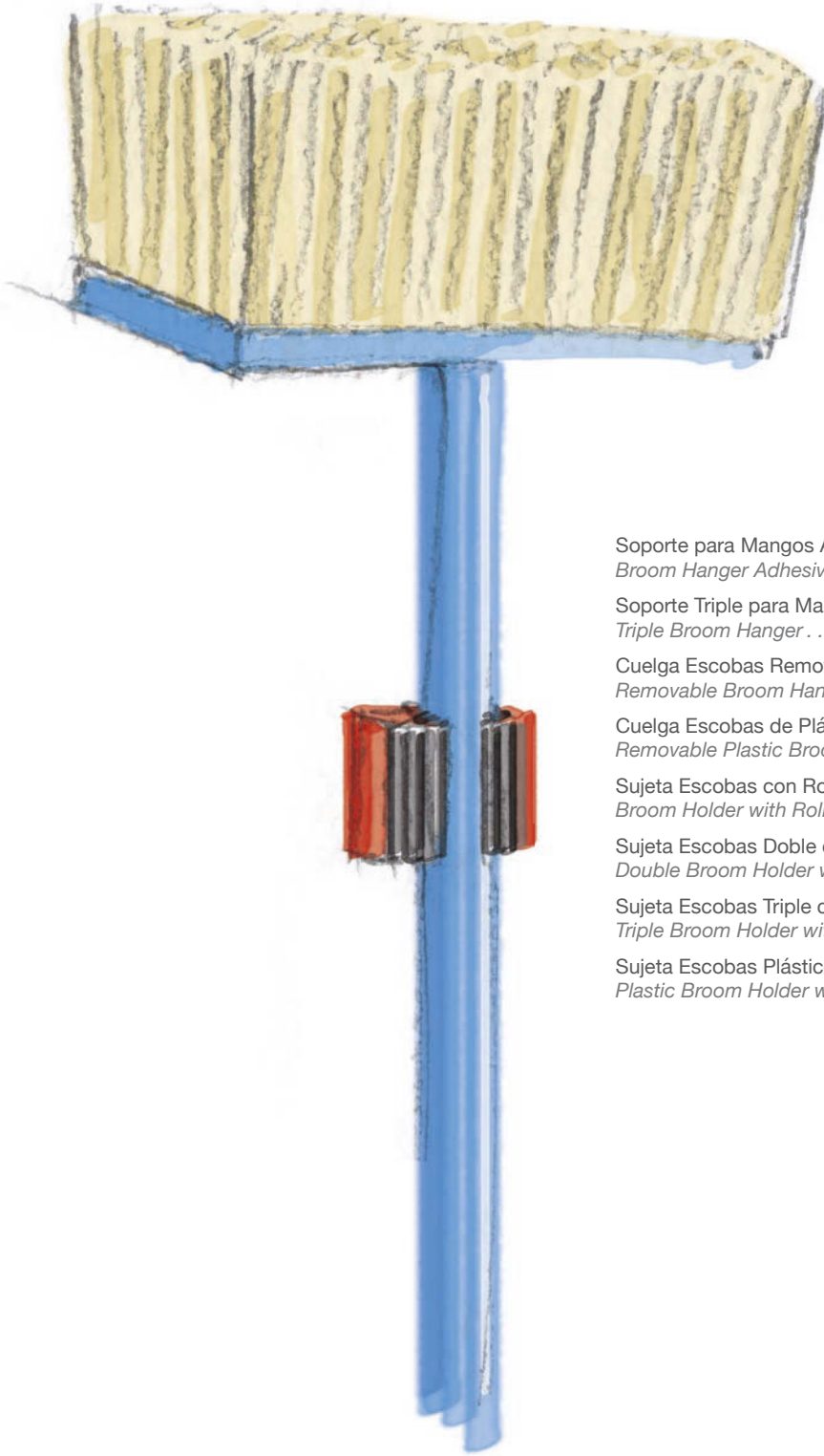

Soporte para Mangos Adhesivo <i>Broom Hanger Adhesive</i> .....	38
Soporte Triple para Mangos <i>Triple Broom Hanger</i> .....	38
Cuelga Escobas Removible <i>Removable Broom Hanger</i> .....	38
Cuelga Escobas de Plástico Removible <i>Removable Plastic Broom Hanger</i> .....	39
Sujeta Escobas con Rodillos <i>Broom Holder with Rollers</i> .....	39
Sujeta Escobas Doble con Rodillos <i>Double Broom Holder with Rollers</i> .....	40
Sujeta Escobas Triple con Rodillos <i>Triple Broom Holder with Rollers</i> .....	41
Sujeta Escobas Plástico con Ganchos Retráctiles <i>Plastic Broom Holder with retractable hooks</i> .....	42

**Soporte para Mangos. Adhesivo**

Soporte para mangos fabricado en Acero Inoxidable de 0,5 mm de espesor.  
Adhesivo de alta calidad.  
Tamaño: 43 x 40 mm

**Broom Hanger**

Made in 0.5 mm thickness stainless steel.  
High quality adhesive.  
Size: 43 x 40 mm

Ref.	Acabado Finish	Código Barras Bar Code
B70400E	Acero Inox Stainless steel	8421196101616

**Soporte Triple para Mangos**

Soporte para mangos fabricado en Acero Inoxidable de 0,5 mm de espesor.  
Modelos multibrazos con ganchos cuelga trapos y con tacos y tornillos para su colocación.  
Tamaño: 300 x 40 mm

**Triple Broom Hanger**

Made in 0.5 mm thickness stainless steel.  
Multi-holder model with hooks.  
Screws and plugs included.  
Size: 300 x 40 mm

Ref.	Acabado Finish	Código Barras Bar Code
B70410E	Acero Inox Stainless steel	8421196101647

**Cuelga Escobas Removable**

Sujeta escobas fabricado en acero lacado.  
Superficie transparente con base de silicona removible de gran poder de absorción.  
No deja residuos y es reutilizable.  
Tamaño: 75 x 100 mm

**Removable Broom Hanger**

Made in lacquered steel.  
Transparent contact surface with removable silicone base. It doesn't leaves residues and is reusable.  
Size: 75 x 100 mm

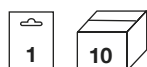

Ref.	Color Colour	Código Barras Bar Code
B53100A	Amarillo Yellow	8421196122680
B53100C	Azul Blue	8421196122918

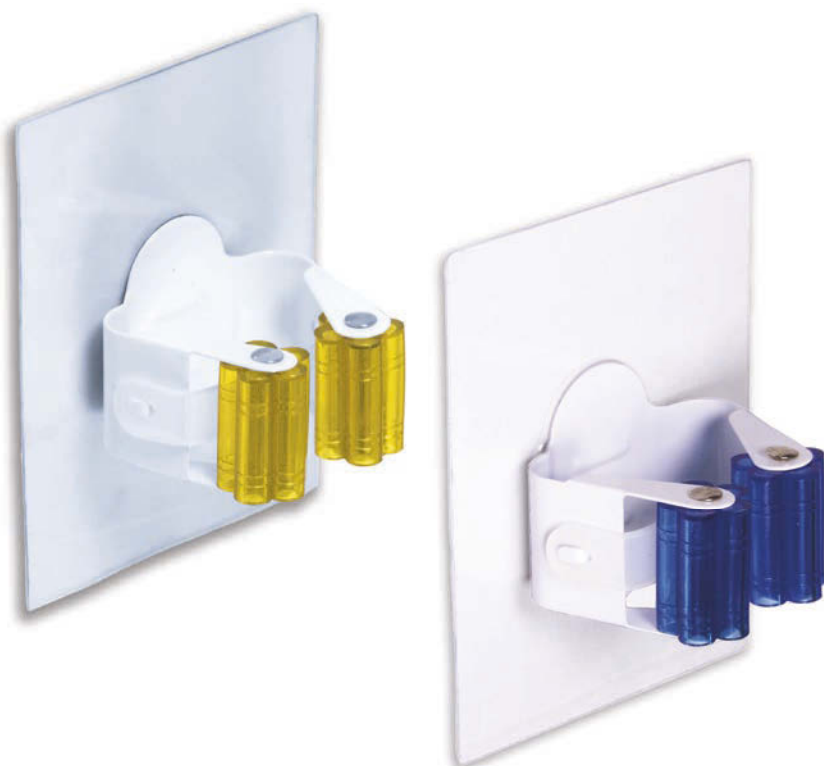

### Cuelga Escobas de Plástico Removable

Sujeta escobas fabricado en plástico.  
Superficie transparente con base de silicona removible de gran poder de absorción.  
No deja residuos y es reutilizable.  
Tamaño: 75 x 100 mm

### Removable Plastic Broom Hanger

Made in plastic.  
Transparent contact surface with removable silicone base. It doesn't leaves residues and is reusable.  
Size: 75 x 100 mm

Ref.	Acabado Finish	Código Barras Bar Code
B53110H	Transparente Transparent	8421196125810

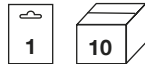

### Sujeta Escobas con Rodillos

Cuelga escobas fabricado en Acero Inoxidable o Lacado. Incluye rodillos giratorios de goma para una colocación más sencilla y un agarre perfecto de los mangos. Su alta flexibilidad permite el uso de una alta diversidad de tamaños de mango. Incluye adhesivo de alta calidad además de ofrecer la posibilidad de colocar con tacos y tornillos desmontando el pasador de la zapatilla central, quedando las cabezas de los tornillos ocultas tras la colocación de la zapatilla. Colocación: Adhesivo. Tamaño: 55 x 35 mm

### Broom Holder with Rollers

Broom holder made in stainless steel or white lacquered. It includes rotating rubber rollers for a easy placement and perfect grip on the handles. Its good flexibility allows to use a wide diversity of handle sizes. High quality adhesive and offers the possibility to be fixed with screws and plugs. For the fixing with screws and plugs: unsettle the stalk of the central element. Insert the screws in the holes. And settle back the central element with its stalk. Screws and plugs are included. Size: 55 x 35 mm



Ref.			Acabado Finish	Código Barras Bar Code
B70640E	2	10	Acero Inox Stainless Steel	8421196105485
B70640D			Lacado Blanco White Lacquered	8421196102705
B70640N			Lacado Negro Black Lacquered	8421196124707
B70640F			Cromado Mate Matt Chrome	8421196119246
B70641E	1	10	Acero Inox Stainless Steel	8421196119215
B70641D			Lacado Blanco White Lacquered	8421196119222
B70641N			Lacado Negro Black Lacquered	8421196124714
B70641F			Cromado Mate Matt Chrome	8421196115743
B70644D	expositor 10 display 10	4 expositores 4 displays	Lacado Blanco White Lacquered	8421196102873





**Sujeta Escobas Doble con Rodillos**

Cuelga escobas fabricado en Acero Inoxidable o Lacado. Incluye rodillos giratorios de goma para una colocación más sencilla y un agarre perfecto de los mangos. Su alta flexibilidad permite el uso de una alta diversidad de tamaños de mango. Modelos de dos sujeta escobas y dos ganchos cuelga trapos.

Incluye tacos y tornillos para su colocación.

Tamaño: 275 x 50 mm

**Double Broom Holder with Rollers**

Broom holder made in stainless steel or white lacquered. It includes spinning rubber rollers for a simple position and perfect sleeve holding. Its good flexibility allows to use a wide diversity of sleeves. Two broom holders and two rag hooks.

Screws and plugs for its fixing included.

Size: 275 x 50 mm

Ref.	Acabado Finish	Código Barras Bar Code
B70650E	Acero Inox Stainless Steel	8421196105492
B70650D	Lacado Blanco White Lacquered	8421196102729
B70650F	Cromado Mate Matt Chrome	8421196115996





**Sujeta Escobas Triple con Rodillos**

Cuelga escobas fabricado en Acero Inoxidable o Lacado. Incluye rodillos giratorios de goma para una colocación más sencilla y un agarre perfecto de los mangos. Su alta flexibilidad permite el uso de una alta diversidad de tamaños de mango. Modelos de tres sujeta escobas y dos ganchos cuelga trapos.

Incluye tacos y tornillos para su colocación.

Tamaño: 420 x 50 mm

**Triple Broom Holder with Rollers**

Broom holder made in stainless steel or white lacquered. It includes spinning rubber rollers for a simple position and perfect sleeve holding. Its good flexibility allows to use a wide diversity of sleeves.

Three broom holders and two rag hooks.

Screws and plugs for fixing are included.

Size: 420 x 50 mm

Ref.	Acabado Finish	Código Barras Bar Code
B70660E	Acero Inox Stainless Steel	8421196105522
B70660D	Lacado Blanco White Lacquered	8421196102743
B70660F	Cromado Mate Matt Chrome	8421196116009







### Sujeta Escobas Plástico con Ganchos Retráctiles

Sujeta Escobas fabricado en plástico de color blanco.

Además de sujetar mangos fácilmente dispone de ganchos retráctiles, perfectos para sujetar trapos u otros elementos del hogar.

La resistencia del material permite sujetar también utensilios de jardinería, tales como palas, rastrillos...

### Plastic Broom Holder with retractable hooks

Brooms made of white plastic.

Includes retractable hooks.

Perfect for holding rags or other household items.

The resistance of the material allows to hold gardening tools such as spades and rakes.

Ref.	Acabado Finish	Código Barras Bar Code
B53000B	3 Mangos + 4 Ganchos 3 Holders + 4 Hooks	8421196119390
B53010B	5 Mangos + 6 Ganchos 5 Holders + 6 Hooks	8421196119406



# Topes para puerta

## Door Stops



Topes Plano Metálico con Tornillo <i>Flat metal Door stop with screw</i> . . . . .	44
Topes Metálico con Tornillo Invisible <i>Metal Door Stop with Invisible Screw</i> . . . . .	44
Topes Metálico redondo <i>Metallic Round Door Stop</i> . . . . .	45
Topes Metálicos cilíndricos <i>Metallic Cylindrical Door Stops</i> . . . . .	45
Topes Metálico cuadrado <i>Metallic Square Door Stop</i> . . . . .	45
Topes Puerta con Tornillo Invisible <i>Door Stop with Invisible Screw</i> . . . . .	46
Topes Bajo con Tornillo <i>Short Door Stop with Screw</i> . . . . .	46
Topes Alto con Tornillo <i>High Door Stop with Screw</i> . . . . .	46
Topes Puerta Grande con Tornillo <i>Large Door Stop with Screw</i> . . . . .	47
Topes Puerta Adhesivo <i>Door Stop. Adhesive</i> . . . . .	47
Topes Puerta Pequeño Adhesivo <i>Small Door Stop. Adhesive</i> . . . . .	48
Topes Puerta Plástico Adhesivo <i>Plastic Door Stop. Adhesive</i> . . . . .	48
Topes Acero para Puertas Adhesivo <i>Steel Door Stop. Adhesive</i> . . . . .	49
Topes de Madera Cilíndrico Adhesivo <i>Cylindrical Wooden Door Stop. Adhesive</i> . . . . .	50
Topes de Madera Cilíndrico con Tornillo Invisible <i>Cylindrical Wooden Door Stop with Invisible screw</i> . . . . .	50
Topes Madera "Luxe" Adhesivo <i>Deluxe Door Stop. Adhesive</i> . . . . .	51
Topes de Madera "Luxe" con Tornillo Invisible <i>Deluxe Wooden Door Stop with Invisible Screw</i> . . . . .	51
Topes Silencioso de Plástico Adhesivo <i>Quiet Door Stop. Adhesive</i> . . . . .	52
Topes Silencioso de Madera Adhesivo <i>Quiet Wooden Door Stop. Adhesive</i> . . . . .	52
Topes Metacrilato con Protector <i>Methacrylate Door Stops with protector</i> . . . . .	53
Topes Metacrilato con Protector Transparente <i>Methacrylate Door Stops with Transparent protector</i> . . . . .	53
Topes y Protectores de Pared <i>Wall Door Stoppers and Protectors</i> . . . . .	54



**Tope Plano Metálico con Tornillo**

Tope para puertas fabricado en Zamak.  
Silenciador de golpes plano de goma.  
Incluye tacos, tornillos y pivote para una correcta colocación.  
Tamaño: Ø 44 x 25 mm

**Flat metal Door stop with screw**

Door stop built in Zamak. Flat rubber shock silencer.  
Includes screw, plug and pivot for mounting.  
Size: Ø 44 x 25 mm



Ref.	Acabado Finish	Código Barras Bar Code
B90200D	Lacado blanco White Lacquered	8421196121973
B90200J	Cromado Chrome	8421196119833
B90200F	Inox Satinado Satin Stainless Steel	8421196119840
B90200K	Oro Gold	8421196119857

**Tope Metálico con Tornillo Invisible**

Tope para puertas macizo de Acero mecanizado por decoletaje. Goma amortiguadora.  
Incluye taco y tornillo invisible para su colocación.  
Tamaño: Ø 22 x 26 mm

**Metal Door Stop with Invisible Screw**

Solid steel door stop. Shock absorber rubber.  
Includes screw and plug for mounting.  
Size: Ø 22 x 26 mm



Ref.	Acabado Finish	Código Barras Bar Code
B90150J	Cromado Chrome	8421196113206
B90150F	Cromado Mate Matt Chrome	8421196115262
B90150K	Oro Gold	8421196117297

**Tope Metálico redondo**

Tope para puertas fabricado en Zamak con goma amortiguadora.  
Acabado en Acero Inoxidable.  
Incluye taco y tornillo invisible para su colocación.  
Tamaño: Ø 55 x 30 mm

**Metallic Round Door Stop**

Door stop made of Zamak with shock absorber rubber.  
Stainless steel finish.  
Includes screw and plug for mounting.  
Size: Ø 55 x 30 mm

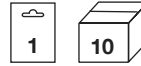

Ref.	Acabado Finish	Código Barras Bar Code
B90250E	Acero Inox Stainless Steel	8421196124851



**Topes Metálico cilíndricos**

Tope para puertas fabricado en Zamak con goma amortiguadora.  
Acabado en Acero Inoxidable.  
Incluye taco y tornillo invisible para su colocación.

**Metallic Cylindrical Door Stops**

Door stop made of Zamak with shock absorber rubber.  
Stainless steel finish.  
Includes screw and plug for mounting.



Ref.	Tamaño Size	Código Barras Bar Code
B90260E	Ø 30 X 40 mm	8421196124868
B90270E	Ø 30 X 70 mm	8421196124875



**Tope Metálico cuadrado**

Tope para puertas fabricado en Zamak con goma amortiguadora. Acabado en Acero Inoxidable.  
Incluye taco y tornillo invisible para su colocación.  
Tamaño: 30 x 31 x 33 mm

**Metallic Square Door Stop**

Door stop made of Zamak with shock absorber rubber.  
Stainless steel finish.  
Includes screw and plug for mounting.  
Size: 30 x 31 x 33 mm



Ref.	Código Barras Bar Code
B90280E	8421196126145



**Tope Puerta con Tornillo Invisible**

Tope para puertas fabricado en goma de PVC.  
Incluye tacos y tornillos invisibles para su colocación.  
Tamaño: Ø 30 x 19 mm

**Door Stop with Invisible Screw**

PVC rubber door stop.  
Includes screw and plug for mounting.  
Size: Ø 30 x 19 mm



Ref.	Color Colour	Código Barras Bar Code
B90020B	Blanco White	8421196104259
B90020M	Marrón Brown	8421196104273
B90020Q	Beige Beige	8421196104280

**Tope Bajo con Tornillo**

Tope para puertas fabricado en goma de PVC para absorber los golpes. Incluye tacos y tornillos para su montaje.  
Tamaño: Ø 29 x 20 mm

**Short Door Stop with Screw**

Short door stop in shock absorber PVC rubber.  
Includes screw and plug for mounting.  
Size: Ø 29 x 20 mm



Ref.	Color Colour	Código Barras Bar Code
B90090B	Blanco White	8421196110946
B90090M	Marrón Brown	8421196110960

**Tope Alto con Tornillo**

Tope para puertas fabricado en goma de PVC para absorber los golpes. Diseño alto para puertas con mayor separación del suelo. Incluye tacos y tornillos para su montaje.  
Tamaño: Ø 29 x 26 mm

**High Door Stop with Screw**

Door stop in shock absorber PVC rubber.  
High design for doors with larger ground clearance.  
Includes screw and plug for mounting.  
Size: Ø 29 x 26 mm



Ref.	Color Colour	Código Barras Bar Code
B90050B	Blanco White	8421196101357
B90050M	Marrón Brown	8421196105188
B90050G	Gris Grey	8421196104709



### Topes Puerta Grande con Tornillo

Topes para puertas fabricado en goma de PVC. Altura de 50 mm para puertas de jardín o con una gran holgura respecto al suelo. Incluye taco y tornillo para su colocación.  
Tamaño: Ø 37 x 50 mm

#### Large Door Stop with Screw

Door stop made of PVC rubber. 50 mm height for garden doors or with a large ground clearance. Includes screw and plug for mounting.  
Size: Ø 37 x 50 mm



Ref.	Color Colour	Código Barras Bar Code
B90210B	Blanco White	8421196121812
B90210M	Marrón Brown	8421196121829
B90210G	Gris Grey	8421196121836
B90210N	Negro Black	8421196121843

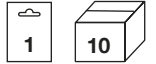

### Topes Puerta Adhesivo

Topes para puertas con base de Acero Inoxidable de 0,6 mm de espesor y goma amortiguadora de PVC. Adhesivo de alta calidad.  
Tamaño: 45 x 45 x 21 mm

#### Door Stop. Adhesive

Adhesive door stop. 0.6 mm thickness stainless steel base and PVC shock absorber rubber. High quality adhesive.  
Size: 45 x 45 x 21 mm



Ref.	Color Colour	Código Barras Bar Code
B90010B	Blanco White	8421196104181
B90010M	Marrón Brown	8421196104204
B90010N	Negro Black	8421196104198
B90010Q	Beige Beige	8421196104211
B90010G	Gris Grey	8421196104228
B90010U	Parquet Marrón Brown Parquet	8421196104235
B90010W	Parquet Beige Beige Parquet	8421196104242
B90010D	Lacado Blanco White Lacquered	8421196107632

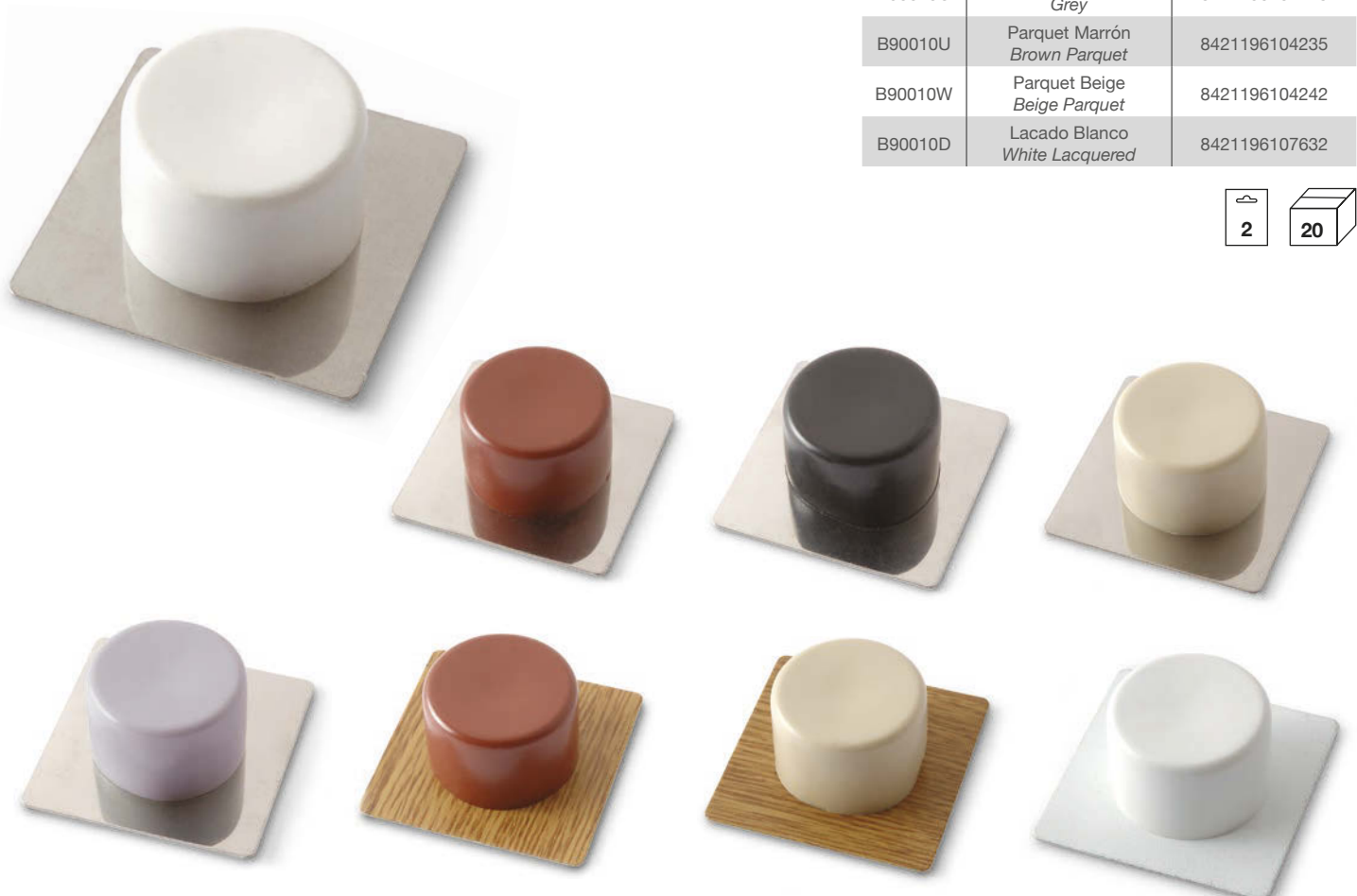



### Topo Puerta Pequeño Adhesivo

Topo para puertas con base de Acero Inoxidable de 0,6 mm de espesor y goma amortiguadora de PVC.

Adhesivo de alta calidad.  
Tamaño: 41 x 41 x 20 mm

#### Small Door Stop. Adhesive

Adhesive door stop with 0.6 mm thickness stainless steel base. PVC shock absorber rubber. High quality adhesive.  
Size: 41 x 41 x 20 mm



Ref.	Color Colour	Código Barras Bar Code
B90060B	Blanco White	8421196112841
B90060M	Marrón Brown	8421196112865
B90060Q	Beige Beige	8421196112872
B90060U	Parquet Marrón Brown parquet	8421196112896
B90060D	Lacado Blanco White Lacquered	8421196113374



### Topo Puerta Plástico Adhesivo

Topo para puertas fabricado en plástico ABS de una pieza.

Adhesivo de alta calidad.  
Tamaño: 42 x 42 x 22 mm

#### Plastic Door Stop. Adhesive

ABS plastic door stop in one piece.  
High quality adhesive.  
Size: 42 x 42 x 22 mm

Ref.	Color Colour	Código Barras Bar Code
B90030B	Blanco White	8421196104303
B90030M	Marrón Brown	8421196104327

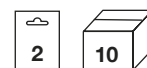



**Tope Acero para Puertas Adhesivo**

Tope para puertas fabricado en Acero lacado. Goma amortiguadora.  
Adhesivo de alta calidad.  
Tamaño: Ø 49 x 22 mm

**Steel Door Stop. Adhesive**

Door stop in lacquered steel.  
Shock absorber rubber.  
High quality adhesive.  
Size: Ø 49 x 22 mm

Ref.	Acabado Finish	Código Barras Bar Code
B90040D	Lacado Blanco White Lacquered	8421196104730
B90040N	Negro Black	8421196100046
B90040M	Marrón Brown	8421196105843
B90040Q	Beige Beige	8421196104785
B90040I	Bronce Bronze	8421196104778
B90040K	Oro Gold	8421196105850
B90040F	Cromado Mate Matt Chrome	8421196114708
B90040J	Cromado Chrome	8421196101227





### Topes de Madera Cilíndrico Adhesivo

Topes para puertas cilíndrico de madera natural. Goma amortiguadora. Adhesivo de alta calidad. Tamaño: Ø 35 x 29 mm

### Cylindrical Wooden Door Stop. Adhesive

Cylindrical door stop in natural wood. Shock absorber rubber. High quality adhesive. Size: Ø 35 x 29 mm



Ref.	Acabado Finish	Código Barras Bar Code
B90130H	Haya Beech	8421196117457
B90130Y	Roble Oak	8421196112995
B90130Z	Sapeli Sapele	8421196113008



### Topes de Madera Cilíndrico con Tornillo Invisible

Topes para puertas cilíndrico de madera natural. Goma amortiguadora. Incluye taco y tornillo invisible para su colocación. Tamaño: Ø 35 x 29 mm

### Cylindrical Wooden Door Stop with Invisible screw

Cylindrical door stop in natural wood. Shock absorber rubber. Includes hidden screw and plug for mounting. Size: Ø 35 x 29 mm



Ref.	Acabado Finish	Código Barras Bar Code
B90120H	Haya Beech	8421196117440
B90120Y	Roble Oak	8421196112964
B90120Z	Sapeli Sapele	8421196112971



**Tope Madera "Luxe" Adhesivo**

Tope para puertas de madera natural. Goma amortiguadora. Adhesivo de alta calidad. Tamaño: 48 x 37 x 25 mm

**Deluxe Door Stop. Adhesive**

Adhesive door stop in natural wood. Shock absorber rubber. High quality adhesive. Size: 48 x 37 x 25 mm

Ref.	Acabado Finish	Código Barras Bar Code
B90080H	Haya Beech	8421196114791
B90080Y	Roble Oak	8421196107991
B90080Z	Sapeli Sapele	8421196107984
B90080D	Lacado Blanco White Lacquered	8421196107977

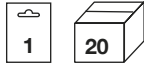

Ref.	Acabado Finish	Código Barras Bar Code
B90084H	Haya Beech	8421196114814
B90084Y	Roble Oak	8421196111226
B90084Z	Sapeli Sapele	8421196111219



Cartón expositor 12 unidades pretroquelado. Display of 12 pre-cut units.

**Tope de Madera "Luxe" con Tornillo Invisible**

Tope para puertas de madera natural. Goma amortiguadora. Incluye taco y tornillo invisible para su colocación. Tamaño: 48 x 37 x 25 mm

**"Luxe" Wooden Door Stop with Invisible Screw**

Door stop in natural wood. Shock absorber rubber. Includes hidden screw and plug for mounting. Size: 48 x 37 x 25 mm



Ref.	Acabado Finish	Código Barras Bar Code
B90140H	Haya Beech	8421196114876
B90140Y	Roble Oak	8421196113046
B90140Z	Sapeli Sapele	8421196113053

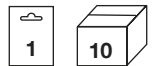



**Topo Silencioso de Plástico Adhesivo**

Topo para puertas de plástico ABS. Espuma amortiguadora para silenciar los golpes. Adhesivo de alta calidad. Tamaño: 48 x 37 x 25 mm

**Quiet Door Stop. Adhesive**

Adhesive and ABS plastic door stop. Shock absorber foam to make the shots quiet. High quality adhesive. Size: 48 x 37 x 25 mm

Ref.	Acabado Finish	Código Barras Bar Code
B90100B	Blanco White	8421196111660
B90100Z	Madera Wood	8421196111677
B90100F	Cromado Mate Matt Chrome	8421196120075

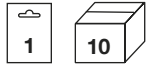
**Topo Silencioso de Madera Adhesivo**

Topo para puertas de madera natural. Espuma amortiguadora para silenciar los golpes. Adhesivo de alta calidad. Tamaño: 48 x 38 x 25 mm

**Quiet Wooden Door Stop. Adhesive**

Adhesive door stop in natural wood. Shock absorber foam to make the shots quiet. High quality adhesive. Size: 48 x 38 x 25 mm

Ref.	Acabado Finish	Código Barras Bar Code
B90110Y	Roble Oak	8421196111875
B90110Z	Sapeli Sapele	8421196111868

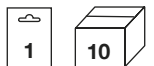

### Topes Metacrilato

Tope para puerta fabricado en SURLYN® transparente de alta resistencia.

Adhesivo transparente de alta calidad

Protector de color negro hecho con espuma en los topes ovalados y planos, y con goma PVC en los topes cilíndricos.

#### Methacrylate Door Stops

Door stop made of transparent high resistance methacrylate.

High quality transparent adhesive.

Black protector made with foam on the oval and flat tops, and with PVC rubber on the cylindrical tops.



Ref.	Forma / Shape Tamaño / Size	Código Barras Bar Code
B90170H	Ovalado / Oval 42 x 39 x 23 mm	8421196119253
B90180H	Cilíndrico / Cylindrical Ø 32 x 33 mm	8421196119260
B90190H	Plano / Flat 46 x 38 x 19 mm	8421196119277



### Topes Metacrilato. Protector Transparente

Tope para puerta fabricado en SURLYN® transparente de alta resistencia.

Adhesivo transparente de alta calidad

Protector de goma transparente.

#### Methacrylate Door Stops. Transparent protector

Door stop made of transparent high resistance methacrylate.

High quality transparent adhesive.

Protector in transparent rubber.



Ref.	Forma / Shape Tamaño / Size	Código Barras Bar Code
B90220H	Ovalado / Oval 42 x 39 x 23 mm	8421196122826
B90230H	Cilíndrico / Cylindrical Ø 32 x 33 mm	8421196122840
B90240H	Plano / Flat 46 x 38 x 19 mm	8421196122864



**Tope Protector Pequeño**

Tope amortiguador de golpes fabricado en plástico.  
Protege puertas y paredes. Incluye adhesivo.  
Tamaño: Ø 40 mm

**Small Shock Protector**

Shock protector made in plastic.  
It protects doors and walls. Includes adhesive.  
Size: Ø 40 mm

Ref.	Acabado Finish		Código Barras Bar Code
B90510B	Blanco White	3	8421196120785
B90511H	Transparente Transparent	2	8421196121966

**Tope Protector Grande**

Tope amortiguador de golpes fabricado en plástico.  
Protege puertas y paredes.  
Incluye adhesivo.  
Tamaño: Ø 60 mm

**Large Shock Protector**

Shock protector made in rubber.  
It protects doors and walls.  
Includes adhesive.  
Size: Ø 60 mm



Ref.	Acabado Finish	Código Barras Bar Code
B90520B	Blanco White	8421196120815

**Tope Metálico de Pared**

Tope para puertas fabricado con base de zamak y barra de aluminio. Acabado en Acero Inoxidable. Goma amortiguadora. Incluye taco y tornillo invisible para su colocación. Tamaño: Ø 30 x 80 mm

**Metallic Door Stop for wall**

Door stop made with a base of zamak and a tube of aluminium. Stainless steel finish. Shock absorber rubber. Includes screw and plug for mounting.  
Size: Ø 30 x 80 mm

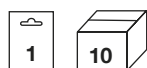

Ref.	Acabado Finish	Código Barras Bar Code
B90530E	Acero Inox Stainless steel	8421196124844



# Retenedores para puertas y ventanas

## Door and window Retainers

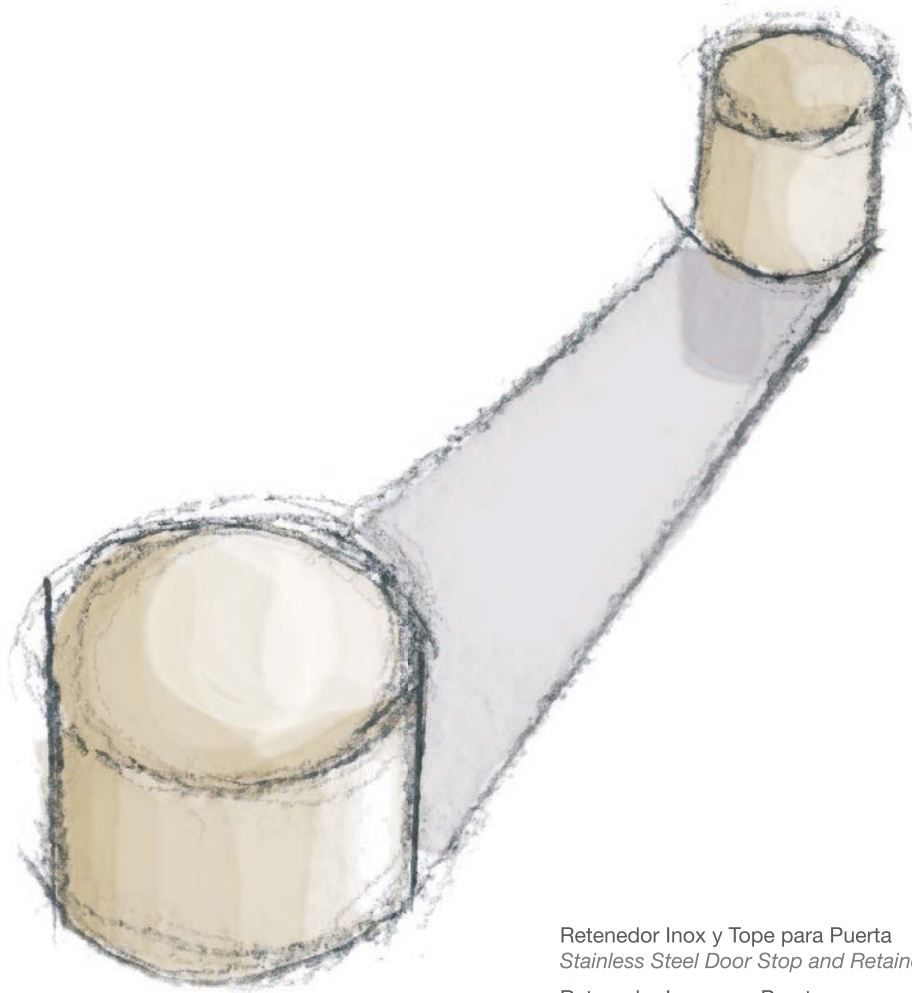

Retenedor Inox y Tope para Puerta <i>Stainless Steel Door Stop and Retainer</i> .....	56
Retenedor Inox para Puerta <i>Stainless Steel Door Retainer</i> .....	56
Tope Retenedor Giratorio. Adhesivo y Tornillo <i>Rotating Door Stop and Retainer</i> .....	57
Tope Retenedor Circular con Imán <i>Cylindrical Magnetized Door Stop and Retainer</i> .....	58
Tope Retenedor Madera con Imán <i>Wooden Door Stop and Retainer with magnet</i> .....	58
Tope Retenedor con Imán <i>Magnetic Door stop and Retainer</i> .....	59
Retenedor Vertical para Puertas <i>Vertical Door Retainer</i> .....	60
Tope Amortiguador para Puertas y Ventanas <i>Shock Absorber for Doors and Windows</i> .....	60



**Retenedor Inox y Tope para Puerta**

Retenedor y tope para puertas fabricado en base de Acero Inoxidable y amortiguador en plástico PVC. Adhesivo de alta calidad.  
Tamaño: 45 x 45 x 48 mm

**Stainless Steel Door Stop and Retainer**

Door stop and retainer. Stainless steel base and PVC plastic shock absorber. High quality adhesive.  
Size: 45 x 45 x 48 mm



Ref.	Color Colour	Código Barras Bar Code
B78220B	Blanco White	8421196103429
B78220M	Marrón Brown	8421196103443
B78220Q	Beige Beige	8421196103450

**Retenedor Inox para Puerta**

Retenedor para puertas fabricado en Acero Inoxidable. Adhesivo de alta calidad.  
Tamaño: 47 x 40 mm

**Stainless Steel Door Retainer**

Stainless steel door retainer. High quality adhesive.  
Size: 47 x 40 mm



Ref.	Acabado Finish	Código Barras Bar Code
B78230E	Acero Inox Stainless steel	8421196103474



**Tope Retenedor Giratorio. Adhesivo y Tornillo**

Tope retenedor giratorio fabricado con una base de Acero Inoxidable y plástico PVC para absorber los golpes. Incluye adhesivo de alta calidad y taco y tornillo para su montaje. Tamaño: 32 x 102 x 22 mm

**Rotating Door Stop and Retainer**

Rotating Door Stop and Retainer. Made with a stainless steel base and PVC plastic shock absorber. High quality adhesive. Screw and plug. Size: 32 x 102 x 22 mm



Ref.	Color Colour	Código Barras Bar Code
B78270B	Blanco White	8421196112025
B78270M	Marrón Brown	8421196112032
B78270N	Negro Black	8421196112056
B78270Q	Beige Beige	8421196112049
B78270D	Lacado Blanco White Lacquered	8421196112407
B78270U	Parquet Marrón Brown parquet	8421196117464
B78270F	Cromado Mate Matt Chrome	8421196117488

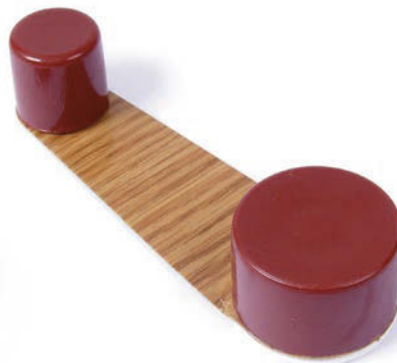

**Tope Retenedor Circular con Imán**

Tope retenedor fabricado en zamac. Imán de alta adherencia. Ideal para puertas pesadas. Placa con dispositivo amortiguador. Incluye tacos y tornillos para su colocación. Tamaño: Ø 41 x 44 mm

**Cylindrical Magnetized Door Stop and Retainer**

Stopper and retainer produced in zamac. High adherence magnet. Ideal for heavy doors. Plate with muffled device. It includes screws and plugs for its setting. Size: Ø 41 x 44 mm



Ref.	Acabado Finish	Código Barras Bar Code
B78290E	Acero Inox Stainless steel	8421196124837

**Tope Retenedor Madera con Imán**

Tope retenedor fabricado en madera natural con imán y placa adhesivada de Acero Inoxidable. Adhesivo de alta calidad. Tamaño: 48 x 36 x 25 mm

**Wooden Door Stop and Retainer with magnet**

Door stop and retainer in natural wood with magnet and stainless steel adhesive plate. High quality adhesive. Size: 48 x 36 x 25 mm



Ref.	Acabado Finish	Código Barras Bar Code
B78280H	Haya Beech	8421196114944
B78280Y	Roble Oak	8421196113176
B78280Z	Sapeli Sapele	8421196113183



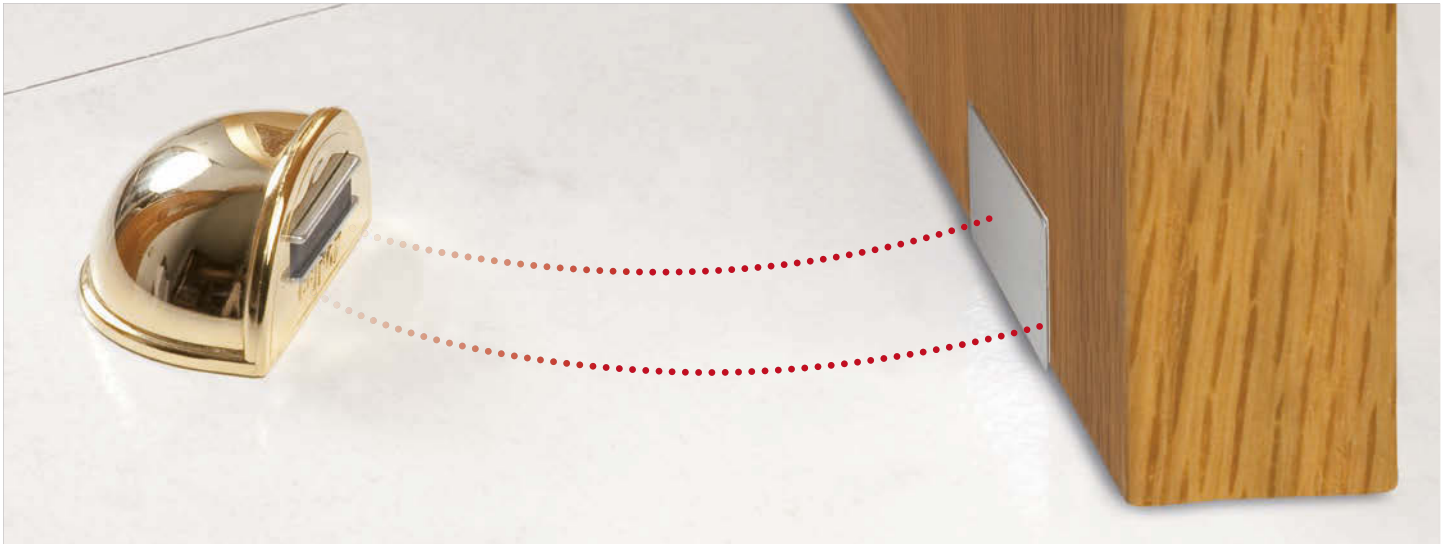

**Tope Retenedor con Imán**

Tope retenedor de plástico ABS con imán y placa adhesivada de Acero Inoxidable.  
Adhesivo de alta calidad.  
Tamaño: 48 x 33 x 25 mm

**Magnetic Door stop and Retainer**

ABS plastic door stop and retainer with magnet and stainless steel adhesive plate.  
High quality adhesive.  
Size: 48 x 33 x 25 mm



Ref.	Acabado Finish	Código Barras Bar Code
B78260B	Blanco White	8421196111486
B78260Z	Madera Wood	8421196111493
B78260Q	Beige Beige	8421196111509
B78260K	Oro Gold	8421196111523
B78260F	Cromado Mate Matt Chrome	8421196114920
B78260J	Cromado Chrome	8421196111530





**Retenedor Vertical para Puertas**

Retenedor vertical para puertas fabricado en Zamak. Con dispositivo expulsor.  
Se acciona y se extrae pisando el mecanismo.  
Tamaño: 27 x 120 mm

**Vertical Door Retainer**

Vertical retainer door produced in Zamak.  
With ejector device.  
Activated and expelled by stepping on the mechanism.  
Size: 27 x 120 mm



Ref.	Acabado Finish	Código Barras Bar Code
B78310F	Inox Satinado Satin Stainless Steel	8421196119802
B78310K	Oro Gold	8421196119819

**Tope Amortiguador para Puertas y Ventanas**

Tope de goma con anzuelo en Acero Inoxidable.  
Mantiene abiertas puertas y ventanas evitando los golpes producidos por portazos, por cierres inesperados y por corrientes de aire.  
Tamaño: 44 x 70 mm

**Shock Absorber for Doors and Windows**

Stopper made in rubber and stainless steel hook.  
Keeps doors and windows open, avoiding bumps caused by unexpected closings.  
Size: 44 x 70 mm



Ref.	Color Colour	Código Barras Bar Code
B78300B	Blanco White	8421196107861

# Protección Infantil

## Children Safety

# BR|kids®

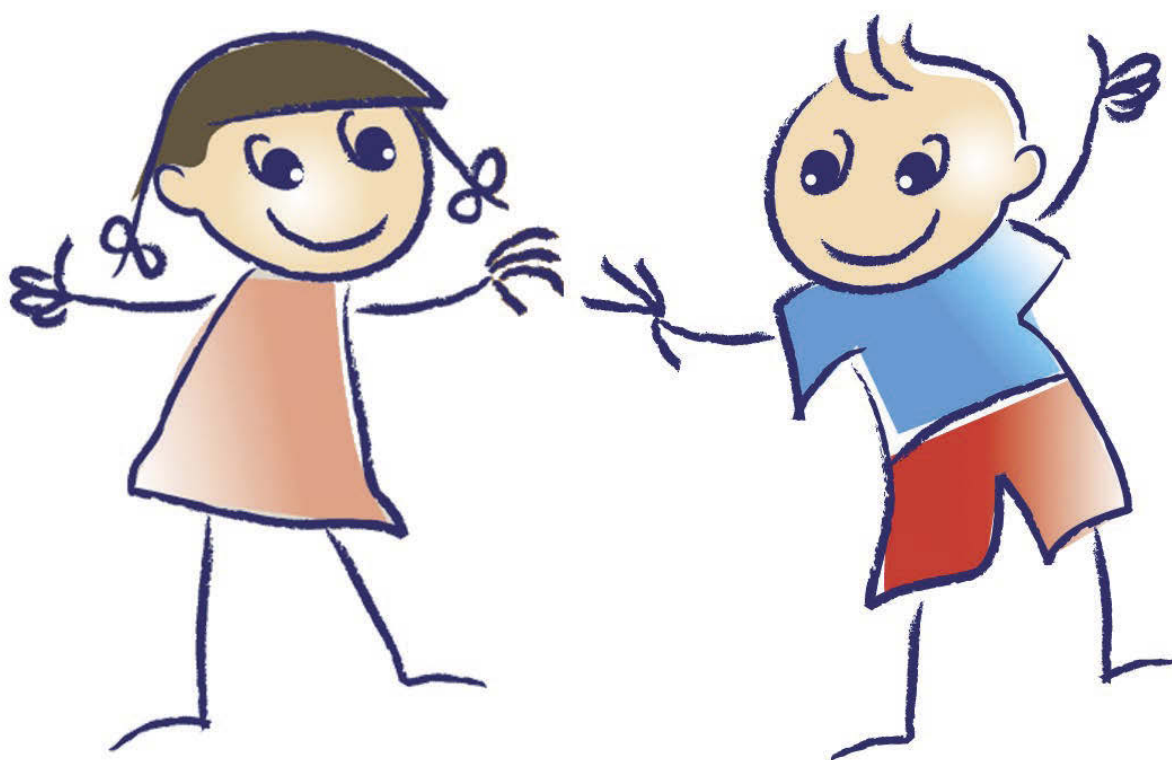

Protege Esquinas <i>Corner Protector</i> .....	62
Cierre de seguridad <i>Safety Locks</i> .....	62
Protectores Salvadedos <i>Finger Guards</i> .....	63
Protectores de Enchufe <i>Plug Protectors</i> .....	64

**Protege Esquinas Silicona**

Protector para muebles de silicona con adhesivo transparente.  
Tamaño: 30 x 30 x 20 mm

**Silicone Corner Protector**

Furniture protector made of silicone with transparent adhesive.  
Size: 30 x 30 x 20 mm



Ref.	Acabado Finish	Código Barras Bar Code
B20010H	Transparente Transparent	8421196120754

**Protege Esquinas Silicona para mesas de cristal**

Protector para mesas de cristal con adhesivo transparente.  
Tamaño: 30 x 30 x 9 mm

**Silicone Corner Protector for glass tables**

Glass table protector made of silicone with transparent adhesive.  
Size: 30 x 30 x 9 mm



Ref.	Acabado Finish	Código Barras Bar Code
B20020H	Transparente Transparent	8421196125735

**Cierre de seguridad para armarios y cajones**

Cierre para muebles de difícil apertura para los niños. Latiguillo flexible de goma transparente y anclajes de plástico ABS con adhesivo de alta calidad.

Tamaño: 176 x 29 mm

**Furniture safety lock**

Difficult-to-open furniture lock for children. Flexible transparent rubber hose and ABS plastic anchors with high quality adhesive.  
Size: 176 x 29 mm



Ref.	Acabado Finish	Código Barras Bar Code
B20510B	Blanco White	8421196122307
B20510H	Transparente Transparent	8421196122314
B20510F	Cromado Mate Matt Chrome	8421196122512



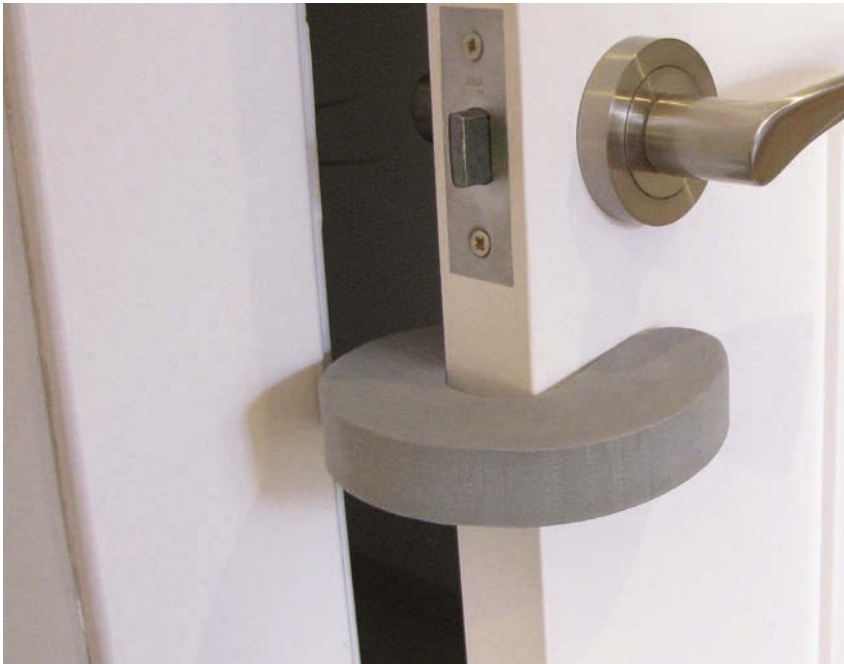

**Protector “Salvadedos” para Puertas y Ventanas**

Protector de espuma en forma de herradura para colocar en puertas. Evita que los niños puedan atraparse los dedos ante un cierre fortuito de la puerta.  
Tamaño: 100 x 100 x 20 mm

**Finger Guard For Doors and Windows**

Foam protector in horseshoe shape to place on doors. It prevents children from catching their fingers in case of fortuitous closure of the door.  
Size: 100 x 100 x 20 mm

Ref.	Color Colour	Código Barras Bar Code
B20110B	Blanco White	8421196120761
B20110G	Gris Grey	8421196120778

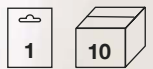

**Protector “Salvadedos” para Bisagras**

Protector de Silicona con gancho en Acero Lacado. Mantiene abiertas puertas y ventanas evitando los pellizcos producidos por portazos, por cierres inesperados y por corrientes de aire.  
Tamaño: 44 x 70 mm

**Finger Guard for Hinges**

Silicone protector with hook in Lacquered Steel. It keeps doors opened avoiding the pinch caused by unexpected closures.  
Size: 44 x 70 mm

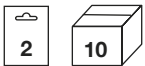

Ref.	Color Colour	Código Barras Bar Code
B20120R	Rojo Red	8421196122529





**Protector de Enchufe con Llave Extractora**

Protector transparente para enchufes. Incluye llave extractora.  
Plástico ignífugo.

Válido para la mayoría de estándares europeos:  
Tipo C (Europlug, CEE 7/17), Tipo E (Francés, CEE 7/5),  
Tipo F (Schuko, CEE 7/4), Tipo E+F (CEE 7/7), Tipo J (Suiza, SEV 1011),  
Tipo L (Italia, CEI 23-16), Tipo IEC (Brasil)

**Plug Protector with Extractor Key**

Transparent protector for plugs. Includes extractor.

Fire retardant plastic.

Valid for most European standards:

Type C (Europlug, CEE 7/17), Type E (France, CEE 7/5),  
Type F (Schuko, CEE 7/4), Type E+F (CEE 7/7), Type J (Switzerland, SEV  
1011), Type L (Italy, CEI 23-16), Type IEC (Brazil)



Ref.	Acabado Finish	Código Barras Bar Code
B20410H	Transparente Transparent	8421196121959

**Protector de Enchufe Giratorio. Adhesivo**

Protector giratorio para enchufes.  
Incluye adhesivo para su colocación.

Válido para la mayoría de estándares europeos:  
Tipo C (Europlug, CEE 7/17), Tipo E (Francés, CEE 7/5),  
Tipo F (Schuko, CEE 7/4), Tipo E+F (CEE 7/7), Tipo J (Suiza, SEV 1011),  
Tipo L (Italia, CEI 23-16), Tipo IEC (Brasil)

**Rotating Plug Protector. Adhesive**

Rotating protector for plugs.

Includes adhesive for placement.

Valid for most European standards:

Type C (Europlug, CEE 7/17), Type E (France, CEE 7/5),  
Type F (Schuko, CEE 7/4), Type E+F (CEE 7/7), Type J (Switzerland, SEV  
1011), Type L (Italy, CEI 23-16), Type IEC (Brazil)

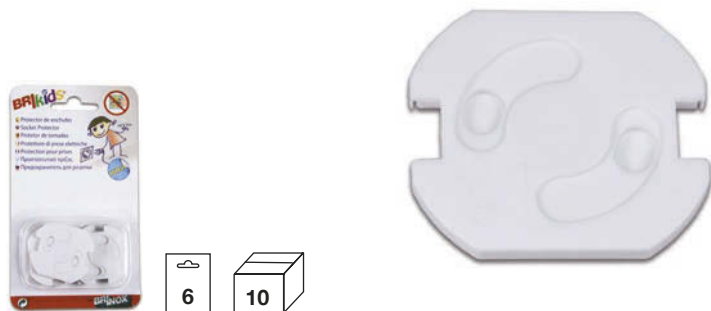

Ref.	Color Colour	Código Barras Bar Code
B20420B	Blanco White	8421196123618

# Tapajuntas

## Joint Covers

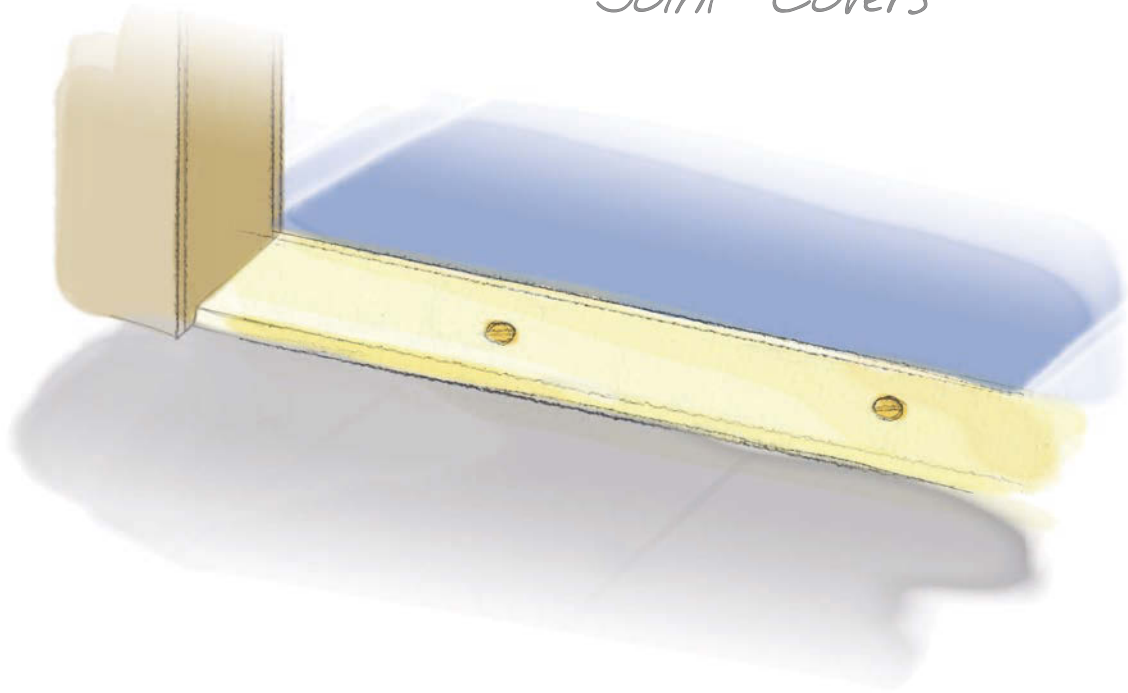

Tapajuntas "Moqueta" con Tornillos <i>Joint Cover "Carpet". With Screws</i> . . . . .	66
Tapajuntas "Moqueta" Estrecho. Adhesivo <i>Joint cover "Carpet" Narrow. Adhesive</i> . . . . .	68
Tapajuntas "Moqueta" Adhesivo <i>Joint cover "Carpet" Adhesive</i> . . . . .	70
Tapajuntas "Moqueta" Ancho con Tornillos <i>Joint Cover "Carpet" Wide with Screws</i> . . . . .	72
Tapajuntas "Moqueta" Aluminio con Tornillos <i>Aluminium Joint Cover "Carpet" with Screws</i> . . . . .	73
Tapajuntas "Moqueta" Aluminio. Adhesivo <i>Aluminium Joint Cover "Carpet" Adhesive</i> . . . . .	73
Tapajuntas "Cerámica" con Tornillos <i>Joint cover "Ceramic" with Screws</i> . . . . .	74
Tapajuntas "Cerámica" Adhesivo <i>Joint cover "Ceramic" Adhesive</i> . . . . .	76
Tapajuntas "Cerámica" Aluminio con Tornillos <i>Aluminium Joint Cover "Ceramic" with Screws</i> . . . . .	78
Tapajuntas "Cerámica" Aluminio. Adhesivo <i>Aluminium Joint cover "Ceramic" Adhesive</i> . . . . .	78
Tapajuntas "Gres" con Tornillos <i>Joint cover "Stoneware" with Screws</i> . . . . .	79
Tapajuntas "Gres" Adhesivo <i>Joint cover "Stoneware" Adhesive</i> . . . . .	79
Tapajuntas "Parquet" con Tornillos <i>Joint cover "Parquet" with Screws</i> . . . . .	80
Tapajuntas "Parquet" Adhesivo <i>Joint cover "Parquet" Adhesive</i> . . . . .	80
Tapacables con Tornillos <i>Cable Protector with Screws</i> . . . . .	81
Tapacables. Adhesivo <i>Cable Protector Adhesive</i> . . . . .	82

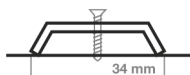



#### Tapajuntas "Moqueta" con Tornillos. Acero Inoxidable

Tapajuntas plano para colocación con tornillos. Ideal para cubrir las juntas entre dos suelos a la misma altura. Las medidas envasadas (hasta 100 cm) incluyen tacos y tornillos para su colocación.  
Ancho: 34 mm

#### Joint Cover "Carpet" with Screws. Stainless Steel

Flat Joint cover to install with screws made in Stainless Steel. Perfect to link two grounds at same level. The Joint cover (till 100 cm) is packed and includes screws and plugs. Width: 34 mm



Ref.	Longitud Length			Código Barras Bar Code
B700803	82 cm	1	10	8421196100732
B700804	100 cm	1	10	8421196100749
B700855	200 cm	x	10	8421196100756

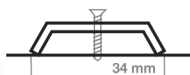



#### Tapajuntas "Moqueta" con Tornillos. Latón

Tapajuntas plano para colocación con tornillos. Ideal para cubrir las juntas entre dos suelos a la misma altura. Las medidas envasadas (hasta 100 cm) incluyen tacos y tornillos para su colocación.  
Ancho: 34 mm

#### Joint Cover "Carpet" with Screws. Brass

Flat Joint cover to install with screws made in Brass. Perfect to link two grounds at same level. The Joint cover (till 100 cm) is packed and includes screws and plugs. Width: 34 mm



Ref.	Longitud Length			Código Barras Bar Code
B701103	82 cm	1	10	8421196100848
B701104	100 cm	1	10	8421196100855
B701155	200 cm	x	10	8421196100862

**Tapajuntas "Moqueta" con Tornillos.**

**Acero Inoxidable decorado en Madera**

Tapajuntas plano de Acero Inoxidable para colocación con tornillos.

Ideal para cubrir las juntas entre dos suelos a la misma altura.

Incluye tacos y tornillos para su colocación.

Ancho: 34 mm

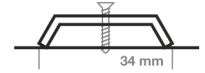

**Joint Cover "Carpet" with Screws.**

**Wooden decorated Stainless Steel**

Flat Joint cover made in decorated Stainless steel, to install with screws.

Perfect to link two grounds at same level.

Includes screws and plugs. Width: 34 mm



Ref.	Longitud Length			Código Barras Bar Code
B712303	82 cm	1	10	8421196106321
B712304	100 cm	1	10	8421196106338
B712355	200 cm	x	10	8421196113398



Ref.	Longitud Length			Código Barras Bar Code
B712903	82 cm	1	10	8421196108158
B712904	100 cm	1	10	8421196108165
B712955	200 cm	x	10	8421196113404





**Tapajuntas "Moqueta" Estrecho Adhesivo. Acero Inoxidable**  
Tapajuntas plano adhesivo de Acero Inoxidable. Ideal para cubrir las juntas entre dos suelos a la misma altura. Ancho: 29 mm

**Joint cover "Carpet" Narrow Adhesive. Stainless Steel**  
Flat Joint cover with Adhesive made in Stainless Steel. Suitable for covering joints between two floors at same level. Width: 29 mm

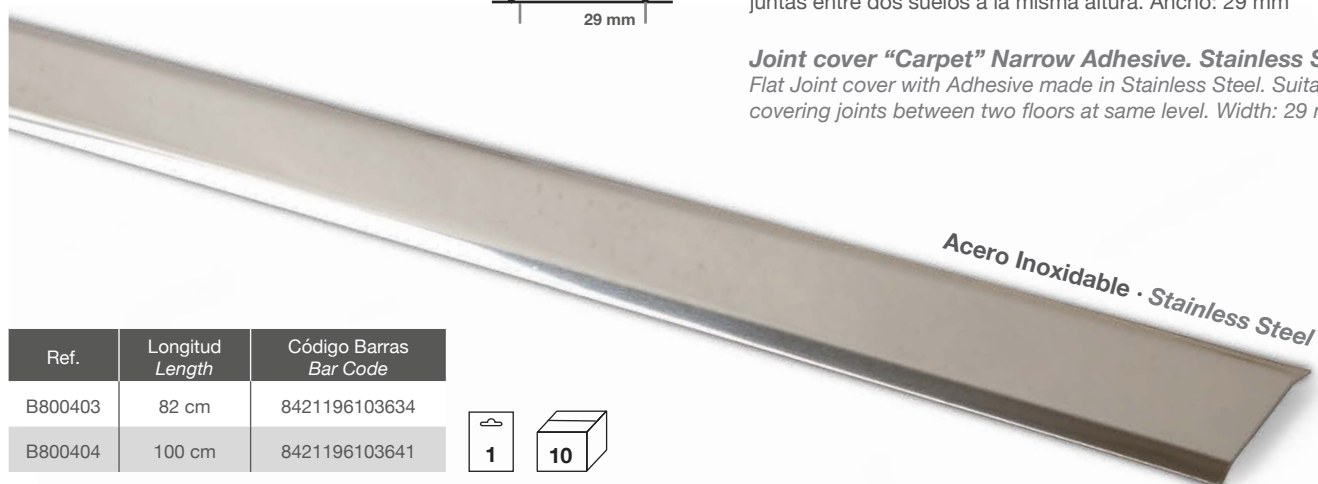

Ref.	Longitud Length	Código Barras Bar Code
B800403	82 cm	8421196103634
B800404	100 cm	8421196103641



**Tapajuntas "Moqueta" Estrecho Adhesivo. Latón**  
Tapajuntas plano adhesivo de Latón. Ideal para cubrir las juntas entre dos suelos a la misma altura. Ancho: 29 mm

**Joint cover "Carpet" Narrow Adhesive. Brass**  
Flat Joint cover with Adhesive made in Brass. Suitable for covering joints between two floors at same level. Width: 29 mm



Ref.	Longitud Length	Código Barras Bar Code
B800703	82 cm	8421196103726
B800704	100 cm	8421196103733



**Tapajuntas "Moqueta" Estrecho Adhesivo.  
Acero Inoxidable decorado en Madera**

Tapajuntas plano adhesivo de Acero Inoxidable. Ideal para cubrir las juntas entre dos suelos a la misma altura. Ancho: 29 mm

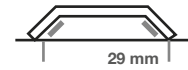

**Joint cover "Carpet" Narrow Adhesive.  
Wooden decorated Stainless Steel**

Flat Joint cover with Adhesive made in Stainless Steel. Suitable for covering joints between two floors at same level. Width: 29 mm



Ref.	Longitud Length	Código Barras Bar Code
B810303	82 cm	8421196106444
B810304	100 cm	8421196106451



Ref.	Longitud Length	Código Barras Bar Code
B810903	82 cm	8421196108196
B810904	100 cm	8421196108202



Ref.	Longitud Length	Código Barras Bar Code
B811303	82 cm	8421196113114
B811304	100 cm	8421196113121





### Tapajuntas "Moqueta" Adhesivo. Acero Inoxidable

Tapajuntas plano adhesivo. Ideal para cubrir las juntas entre dos suelos a la misma altura. Ancho: 35 mm



### Joint Cover "Carpet" Adhesive. Stainless Steel

Flat Joint cover adhesive made in Stainless Steel.  
Perfect to link two grounds at same level. Width: 35 mm



Acero Inoxidable · Stainless Steel



Ref.	Longitud Length			Código Barras Bar Code
B811503	82 cm	1	10	8421196115460
B811504	100 cm	1	10	8421196115514
B811555	200 cm	x	10	8421196116375

### Tapajuntas "Moqueta" Adhesivo. Latón

Tapajuntas plano adhesivo. Ideal para cubrir las juntas entre dos suelos a la misma altura. Ancho: 35 mm

### Joint Cover "Carpet" Adhesive. Brass

Flat Joint cover adhesive made in brass.  
Perfect to link two grounds at same level. Width: 35 mm



Latón · Brass



Ref.	Longitud Length	Código Barras Bar Code
B811603	82 cm	8421196115477
B811604	100 cm	8421196115521



**Tapajuntas "Moqueta" Adhesivo.**

**Acero Inoxidable decorado en Madera**

Tapajuntas plano adhesivo. Ideal para cubrir las juntas entre dos suelos a la misma altura. Ancho: 35 mm

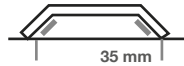

**Joint Cover "Carpet" Adhesive.**

**Wooden decorated Stainless Steel**

Flat Joint cover adhesive made in Stainless Steel.  
Perfect to link two grounds at same level. Width: 35 mm

Madera Clara · Clear wood

Ref.	Longitud Length			Código Barras Bar Code
B811703	82 cm	1	10	8421196115484
B811704	100 cm	1	10	8421196115538
B811755	200 cm	x	10	8421196116412

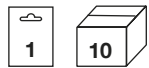

Ref.	Longitud Length	Código Barras Bar Code
B811803	82 cm	8421196115491
B811804	100 cm	8421196115545

Madera Oscura · Dark wood

Madera Pino · Pine wood

Ref.	Longitud Length	Código Barras Bar Code
B811903	82 cm	8421196115507
B811904	100 cm	8421196115552

Madera Haya · Beech wood

Ref.	Longitud Length	Código Barras Bar Code
B812403	82 cm	8421196118393
B812404	100 cm	8421196118409



**Tapajuntas "Moqueta" Ancho con Tornillos. Acero Inoxidable**

Tapajuntas plano para colocación con tornillos.

Ideal para cubrir las juntas entre dos suelos a la misma altura.

Las medidas envasadas (hasta 100 cm) incluyen tacos y tornillos para su colocación.

Ancho: 51 mm



**Joint Cover "Carpet" Wide with Screws. Stainless Steel**

Flat Joint cover to install with screws.

Perfect to link two grounds at same level.

The Joint cover (till 100 cm) is packed and includes screws and plugs.

Width: 51 mm

Ref.	Longitud Length			Código Barras Bar Code
B710203	82 cm	1	10	8421196102361
B710204	100 cm	1	10	8421196102323
B710255	200 cm	x	10	8421196115224

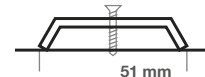
**Tapajuntas "Moqueta" Ancho con Tornillos. Latón**

Tapajuntas plano para colocación con tornillos.

Ideal para cubrir las juntas entre dos suelos a la misma altura.

Incluye tacos y tornillos para su colocación.

Ancho: 51 mm



**Joint Cover "Carpet" Wide with Screws. Brass**

Flat Joint cover to install with screws.

Perfect to link two grounds at same level.

Includes screws and plugs.

Width: 51 mm

Ref.	Longitud Length			Código Barras Bar Code
B710303	82 cm	1	10	8421196102262
B710304	100 cm	1	10	8421196102293

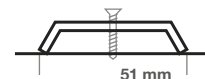

### Tapajuntas "Moqueta" Aluminio con Tornillos

Tapajuntas plano para colocación con tornillos, fabricado en aluminio extrusionado. Perfil con plano de sierra antideslizante. Ideal para cubrir las juntas entre dos suelos a la misma altura. Las medidas envasadas (hasta 100 cm) incluyen tacos y tornillos para su colocación. Ancho: 40 mm

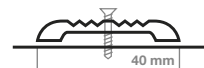

### Aluminium Joint Cover "Carpet" with Screws

Flat Joint cover to install with screws. Made in extruded aluminium. Non-skid surface. Perfect to link two grounds at same level. The Joint cover (till 100 cm) is packed and includes screws and plugs. Width: 40 mm



Ref.	Longitud Length			Código Barras Bar Code
B712103	82 cm	1	10	8421196106284
B712104	100 cm	1	10	8421196106291
B712155	200 cm	x	10	8421196116122

Ref.	Longitud Length			Código Barras Bar Code
B712503	82 cm	1	10	8421196106369
B712504	100 cm	1	10	8421196106376
B712555	200 cm	x	10	8421196113343

### Tapajuntas "Moqueta" Aluminio Adhesivo

Tapajuntas plano adhesivo, fabricado en aluminio extrusionado. Perfil con plano de sierra antideslizante. Ideal para cubrir las juntas entre dos suelos a la misma altura. Ancho: 40 mm

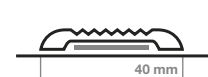

### Aluminium Joint Cover "Carpet" Adhesive

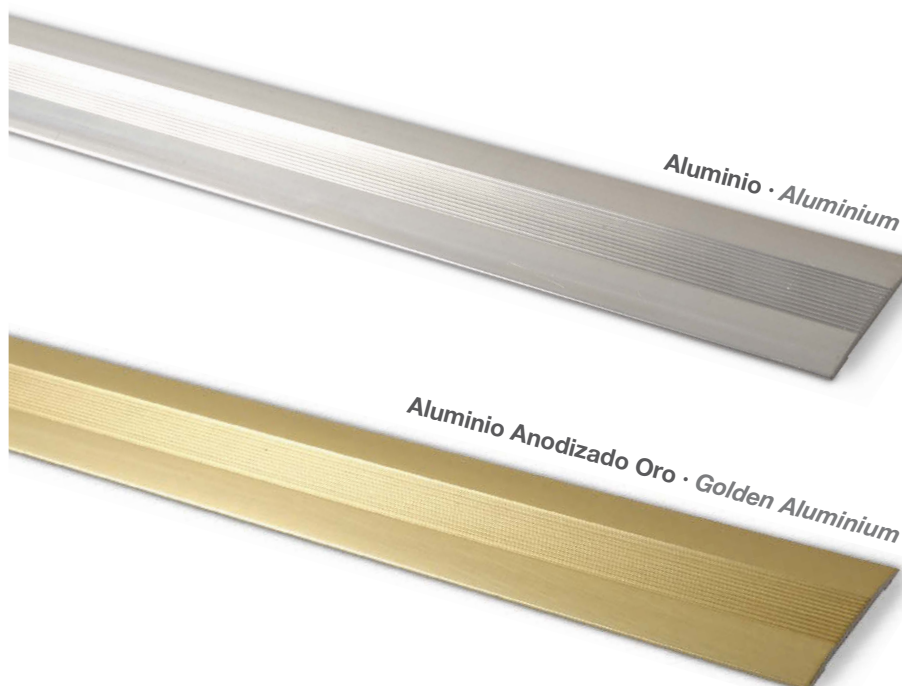

Flat Joint cover adhesive. Made in extruded aluminium. Non-skid surface. Perfect to link two grounds at same level. Width: 40 mm



Ref.	Longitud Length	Código Barras Bar Code
B810103	82 cm	8421196106406
B810104	100 cm	8421196106413

Ref.	Longitud Length	Código Barras Bar Code
B810503	82 cm	8421196106482
B810504	100 cm	8421196106499



Ref.	Longitud Length			Código Barras Bar Code
B700903	82 cm	1	10	8421196100770
B700904	100 cm	1	10	8421196100787
B700955	200 cm	x	10	8421196100794

#### Tapajuntas "Cerámica" con Tornillos. Acero Inoxidable

Tapajuntas inclinado para colocación con tornillos.



Ideal para cubrir las juntas entre dos suelos a distinta altura, desde 8 hasta 12 mm. Las medidas envasadas (hasta 100 cm) incluyen tacos y tornillos para su colocación. Ancho: 41 mm

#### Joint cover "Ceramic" with Screws. Stainless Steel

Oblique Joint cover to install with screws.

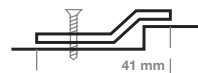
Perfect to link two different level grounds from 8 to 12 mm. The Joint cover (till 100 cm) is packed and includes screws and plugs. Width: 41 mm



Ref.	Longitud Length			Código Barras Bar Code
B701203	82 cm	1	10	8421196100886
B701204	100 cm	1	10	8421196100893

#### Tapajuntas "Cerámica" con Tornillos. Latón

Tapajuntas inclinado para colocación con tornillos.

Ideal para cubrir las juntas entre dos suelos a distinta altura, desde 8 hasta 12 mm. Las medidas envasadas (hasta 100 cm) incluyen tacos y tornillos para su colocación. Ancho: 41 mm

#### Joint cover "Ceramic" with Screws. Brass

Oblique Joint cover to install with screws. Perfect to link two different level grounds from 8 to 12 mm. The Joint cover (till 100 cm) is packed and includes screws and plugs. Width: 41 mm

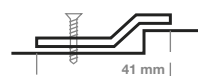



**Tapajuntas "Cerámica" con Tornillos.**

**Acero Inoxidable decorado en Madera**

Tapajuntas inclinado para colocación con tornillos. Ideal para cubrir las juntas entre dos suelos a distinta altura, desde 8 hasta 12 mm  
Incluye tacos y tornillos para su colocación. Ancho: 41 mm

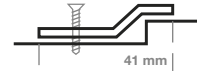

**Joint cover "Ceramic" with Screws.**

**Wooden decorated Stainless Steel**

Oblique Joint cover to install with screws. Perfect to link two different level grounds from 8 to 12 mm. Include screws and plugs. Width: 41 mm

Madera Clara · Clear wood

Ref.	Longitud Length			Código Barras Bar Code
B712403	82 cm	1	10	8421196106345
B712404	100 cm	1	10	8421196106352

Madera Oscura · Dark wood

Ref.	Longitud Length			Código Barras Bar Code
B713003	82 cm	1	10	8421196108172
B713004	100 cm	1	10	8421196108189





#### Tapajuntas "Cerámica" Adhesivo. Acero Inoxidable

Tapajuntas inclinado adhesivo de Acero Inoxidable. Ideal para cubrir las juntas entre dos suelos a distinta altura, desde 8 hasta 12 mm. Ancho: 41 mm

#### Joint cover "Ceramic" Adhesive. Stainless Steel

Oblique Joint cover adhesive made of Stainless Steel.  
Perfect to link two different level grounds from 8 to 12 mm. Width: 41 mm



Ref.	Longitud Length	Código Barras Bar Code
B800503	82 cm	8421196103665
B800504	100 cm	8421196103672



#### Tapajuntas "Cerámica" Adhesivo. Latón

Tapajuntas inclinado adhesivo de latón. Ideal para cubrir las juntas entre dos suelos a distinta altura, desde 8 hasta 12 mm. Ancho: 41 mm

#### Joint cover "Ceramic" Adhesive. Brass

Oblique Joint cover adhesive made of brass.  
Perfect to link two different level grounds from 8 to 12 mm. Width: 41 mm



Ref.	Longitud Length	Código Barras Bar Code
B800803	82 cm	8421196103757
B800804	100 cm	8421196103764



**Tapajuntas "Cerámica" Adhesivo.  
Acero Inoxidable decorado en Madera**

Tapajuntas inclinado adhesivo de Acero Inoxidable. Ideal para cubrir las juntas entre dos suelos a distinta altura, desde 8 hasta 12 mm. Ancho: 41 mm



**Joint cover "Ceramic" Adhesive.  
Wooden decorated Stainless Steel**

Oblique Joint cover adhesive made of Stainless Steel. Perfect to link two different level grounds from 8 to 12 mm. Width: 41 mm

Madera Clara · Clear wood

Ref.	Longitud Length	Código Barras Bar Code
B810403	82 cm	8421196106468
B810404	100 cm	8421196106475

Madera Oscura · Dark wood

Ref.	Longitud Length	Código Barras Bar Code
B811003	82 cm	8421196108219
B811004	100 cm	8421196108226

Madera Pino · Pine wood

Ref.	Longitud Length	Código Barras Bar Code
B811403	82 cm	8421196113138
B811404	100 cm	8421196113145

Madera Haya · Beech wood

Ref.	Longitud Length	Código Barras Bar Code
B812503	82 cm	8421196118416
B812504	100 cm	8421196118423

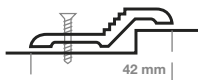

### Tapajuntas "Cerámica" Aluminio con Tornillos

Tapajuntas inclinado para colocación con tornillos, fabricado en aluminio extrusionado. Perfil con marcas de sierra antideslizante. Ideal para cubrir las juntas entre dos suelos a distinta altura, desde 8 hasta 12 mm. Incluye tacos y tornillos para su colocación. Ancho: 42 mm

#### Aluminium Joint Cover "Ceramic" with Screws

Oblique Joint cover to install with screws. Made in extruded aluminium. Non-skid surface. Perfect to link two different level grounds from 8 to 12 mm. Screws and plugs included. Width: 42 mm

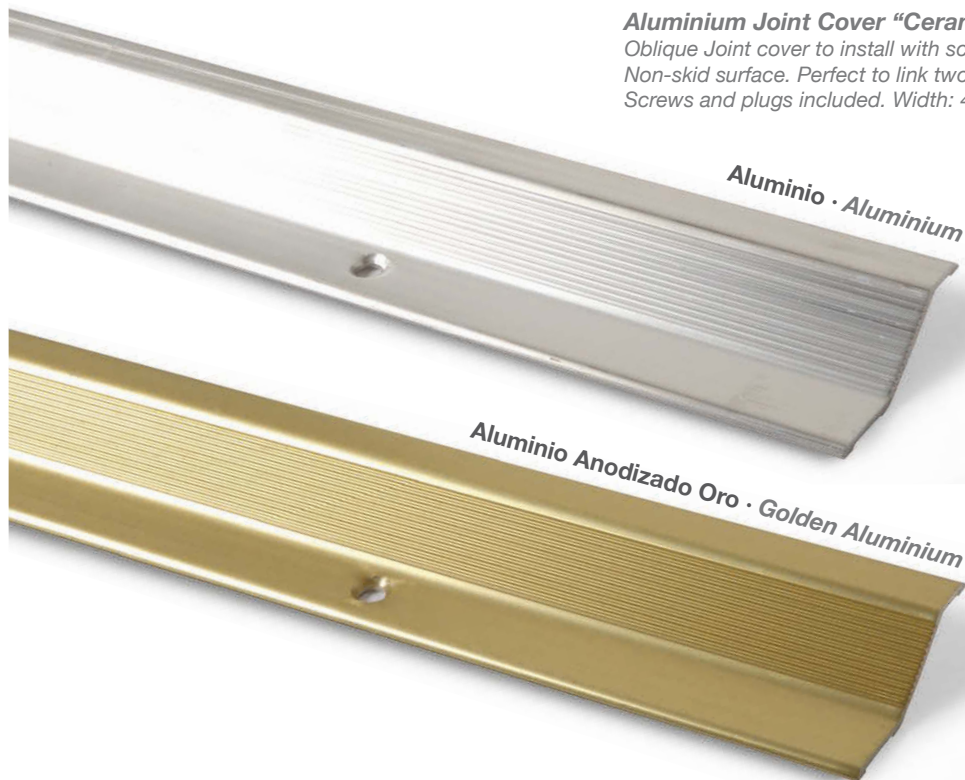

Ref.	Longitud Length	Código Barras Bar Code
B712203	82 cm	8421196106307
B712204	100 cm	8421196106314

Ref.	Longitud Length	Código Barras Bar Code
B712603	82 cm	8421196106383
B712604	100 cm	8421196106390



### Tapajuntas "Cerámica" Aluminio. Adhesivo

Tapajuntas inclinado adhesivo, fabricado en aluminio extrusionado. Perfil con marcas de sierra antideslizante. Ideal para cubrir las juntas entre dos suelos a la misma altura. Ancho: 42 mm

#### Aluminium Joint Cover "Ceramic". Adhesive

Oblique Joint cover adhesive, made in extruded aluminium. Non-skid surface. Perfect to link two different level grounds from 8 to 12 mm. Width: 42 mm

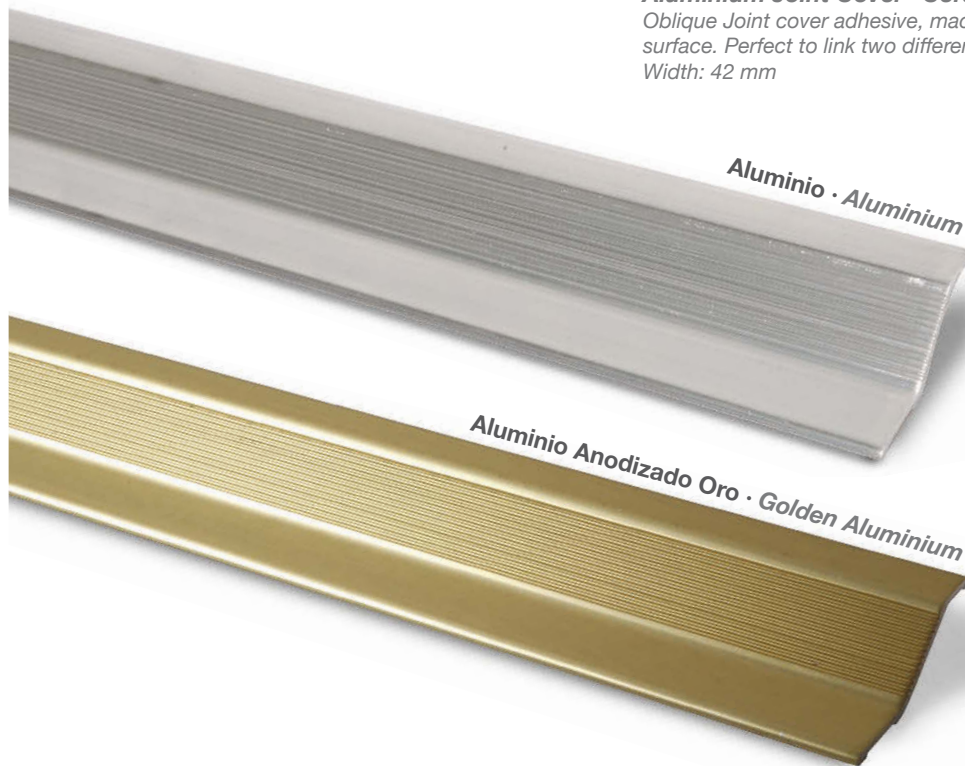

Ref.	Longitud Length	Código Barras Bar Code
B810203	82 cm	8421196106420
B810204	100 cm	8421196106437

Ref.	Longitud Length	Código Barras Bar Code
B810603	82 cm	8421196106505
B810604	100 cm	8421196106512





Ref.	Longitud Length	Código Barras Bar Code
B700503	82 cm	8421196104976
B700504	100 cm	8421196104983

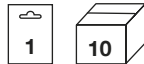

**Tapajuntas "Gres" con Tornillos.  
Acero Inoxidable**

Tapajuntas en escalón para colocación con tornillos. Ideal para cubrir las juntas entre dos suelos a distinta altura, desde 10 hasta 15 mm. Incluye tacos y tornillos para su colocación. Ancho: 44 mm

**Joint cover "Stoneware" with  
Screws. Stainless Steel**

Stair shape Joint cover to install with screws. Perfect to link two different level grounds from 10 to 15 mm. Screws and plugs included. Width: 44 mm



Ref.	Longitud Length	Código Barras Bar Code
B700603	82 cm	8421196105003
B700604	100 cm	8421196105010

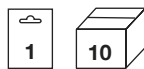

**Tapajuntas "Gres" con Tornillos.  
Latón**

Tapajuntas en escalón para colocación con tornillos. Ideal para cubrir las juntas entre dos suelos a distinta altura, desde 10 hasta 15 mm. Incluye tacos y tornillos para su colocación. Ancho: 44 mm

**Joint cover "Stoneware" with Screws.  
Brass**

Stair shape Joint cover to install with screws. Perfect to link two different level grounds from 10 to 15 mm. Screws and plugs included. Width: 44 mm



Ref.	Longitud Length	Código Barras Bar Code
B801703	82 cm	8421196105720
B801704	100 cm	8421196105737



**Tapajuntas "Gres" Adhesivo.  
Acero Inoxidable**

Tapajuntas en escalón adhesivo. Ideal para cubrir las juntas entre dos suelos a distinta altura, desde 10 hasta 15 mm. Ancho: 44 mm

**Joint cover "Stoneware"  
Adhesive. Stainless Steel**

Stair shape Joint cover adhesive. Perfect to link two different level grounds from 10 to 15 mm. Width: 44 mm



Ref.	Longitud Length	Código Barras Bar Code
B801803	82 cm	8421196105768
B801804	100 cm	8421196105775



**Tapajuntas "Gres" Adhesivo.  
Latón**

Tapajuntas en escalón adhesivo. Ideal para cubrir las juntas entre dos suelos a distinta altura, desde 10 hasta 15 mm. Ancho: 44 mm

**Joint cover "Stoneware" Adhesive.  
Brass**

Stair shape Joint cover adhesive. Perfect to link two different level grounds from 10 to 15 mm. Width: 44 mm

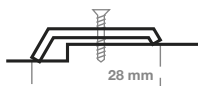

**Tapajuntas "Parquet" con Tornillos. Acero Inoxidable**

Tapajuntas desnivelado para colocación con tornillos.  
Ideal para cubrir las juntas entre dos suelos a distinta altura, desde 2 hasta 6 mm. Incluye tacos y tornillos para su colocación.  
Ancho: 28 mm

**Joint cover "Parquet" with Screws. Stainless Steel**

Uneven Joint cover to install with screws.  
Perfect to link two different height grounds from 2 to 6 mm  
Screws and plugs included.  
Width: 28 mm

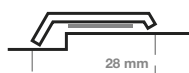

Ref.	Longitud Length	Código Barras Bar Code
B700703	82 cm	8421196100701
B700704	100 cm	8421196100718

**Tapajuntas "Parquet" Adhesivo. Acero Inoxidable**

Tapajuntas desnivelado adhesivo. Ideal para cubrir las juntas entre dos suelos a distinta altura, desde 2 hasta 6 mm  
Ancho: 28 mm

**Joint cover "Parquet" Adhesive. Stainless Steel**

Uneven Joint cover adhesive.  
Perfect to link two different level grounds from 2 to 6 mm  
Width: 28 mm



Ref.	Longitud Length	Código Barras Bar Code
B800303	82 cm	8421196103603
B800304	100 cm	8421196103610

**Tapajuntas "Parquet" Adhesivo. Latón**

Tapajuntas desnivelado adhesivo. Ideal para cubrir las juntas entre dos suelos a distinta altura, desde 2 hasta 6 mm  
Ancho: 28 mm

**Joint cover "Parquet" Adhesive. Brass**

Joint cover adhesive.  
Perfect to link two different level grounds from 2 to 6 mm  
Width: 28 mm

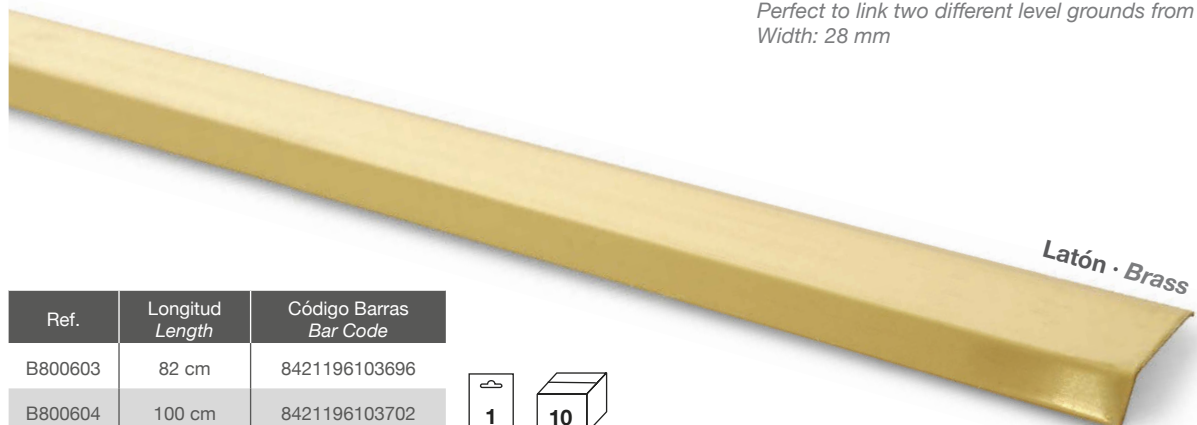

Ref.	Longitud Length	Código Barras Bar Code
B800603	82 cm	8421196103696
B800604	100 cm	8421196103702







**Tapacables con Tornillos. Acero Inoxidable**

Perfil metálico tapacables para colocación con tornillos. Alta resistencia, ideal para el paso de cables incluso en zonas de paso. La medida envasada (100 cm) incluye tacos y tornillos para su colocación. Ancho: 53 mm

**Cable Protector with Screws. Stainless Steel**

Metallic cable protector for a screw fixing. High resistance. Ideal for the passage of cables in the trampled area. Packed size (100 cm) includes screws and plugs for its fixing. Width: 53 mm



Ref.	Longitud Length			Código Barras Bar Code
B701304	100 cm	1	10	8421196100916
B701355	200 cm	x	10	8421196100923



**Tapacables con Tornillos. Latón**

Perfil metálico tapacables para colocación con tornillos. Alta resistencia, ideal para el paso de cables incluso en zonas de paso. La medida envasada (100 cm) incluye tacos y tornillos para su colocación. Ancho: 53 mm

**Cable Protector with Screws. Brass**

Metallic cable protector for a screw fixing. High resistance. Ideal for the passage of cables in the trampled area. Packed size (100 cm) includes screws and plugs for its fixing. Width: 53 mm



Ref.	Longitud Length	Código Barras Bar Code
B701404	100 cm	8421196100930



**Tapacables Adhesivo. Acero Inoxidable**

Perfil metálico tapacables adhesivo. Alta resistencia. Ideal para el paso de cables incluso en zonas de paso. Ancho: 53 mm

**Cable Protector Adhesive. Stainless Steel**

Metallic cable protector with adhesive. High resistance. Ideal for the passage of cables in the trampled area. Width: 53 mm



Ref.	Longitud Length	Código Barras Bar Code
B800904	100 cm	8421196103771

**Tapacables Adhesivo. Latón**

Perfil metálico tapacables adhesivo. Alta resistencia, ideal para el paso de cables incluso en zonas de paso. Ancho: 53 mm

**Cable Protector Adhesive. Brass**

Metallic cable protector with adhesive. High resistance. Ideal for the passage of cables in the trampled area. Width: 53 mm

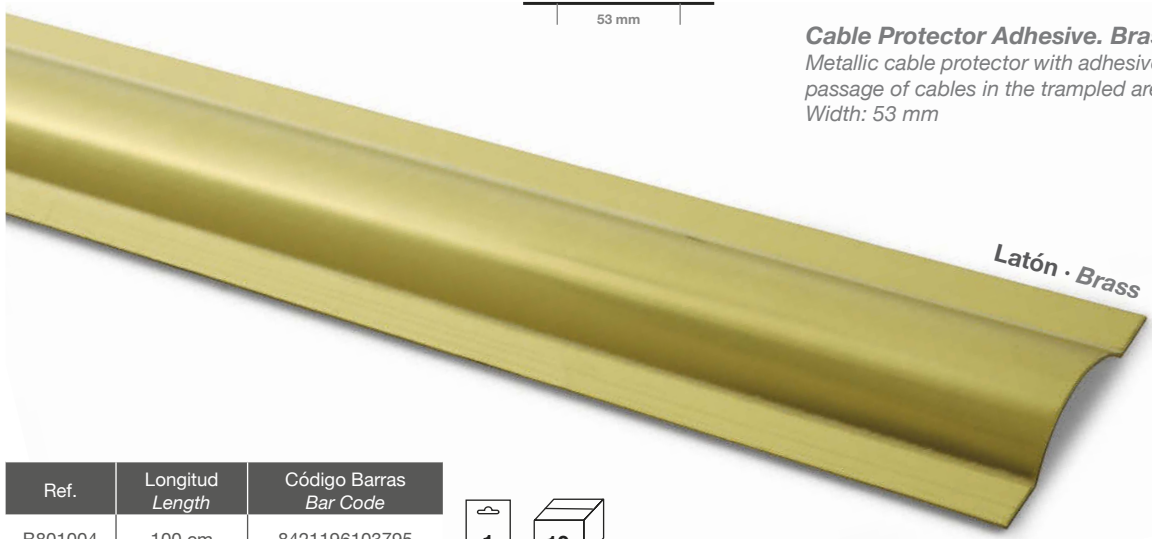

Ref.	Longitud Length	Código Barras Bar Code
B801004	100 cm	8421196103795



# Rejillas de Ventilación

## Ventilation Grids

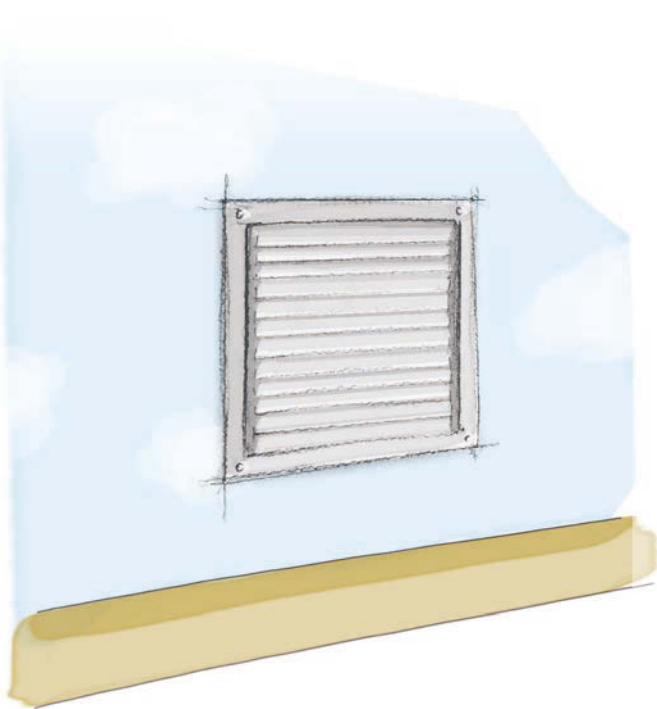

Rejilla Cuadrada. 10 x 10 cm Ventilation Grid. Square 10 x 10 cm .....	84
Rejilla Cuadrada. 15 x 15 cm Ventilation Grid. Square 15 x 15 cm .....	84
Rejilla Cuadrada. 17 x 17 cm Ventilation Grid. Square 17 x 17 cm .....	85
Rejilla Cuadrada. 18 x 18 cm. 19 Aberturas Ventilation Grid. Square 18 x 18 cm. 19 Slits .....	85
Rejilla Cuadrada. 20 x 20 cm Ventilation Grid. Square 20 x 20 cm .....	86
Rejilla Cuadrada. 30 x 30 cm Ventilation Grid. Square 30 x 30 cm .....	86
Rejilla Cuadrada. 15 x 15 cm. Adhesiva Ventilation Grid. Square 15 x 15 cm. Adhesive .....	87
Rejilla Cuadrada. 17 x 17 cm. Adhesiva Ventilation Grid. Square 17 x 17 cm. Adhesive .....	87
Rejilla Cuadrada. 18 x 18 cm. 19 Aberturas. Adhesiva Ventilation Grid. Square 18 x 18 cm. 19 Slits. Adhesive .....	88
Rejilla Cuadrada. 20 x 20 cm. Adhesiva Ventilation Grid. Square 20 x 20 cm. Adhesive .....	88
Rejilla Horizontal. 10 x 20 cm Horizontal Ventilation Grid. 10 x 20 cm .....	88
Rejilla Horizontal. 15 x 30 cm Horizontal Ventilation Grid. 15 x 30 cm .....	89
Rejilla Horizontal. 20 x 40 cm Horizontal Ventilation Grid. 20 x 40 cm .....	90
Rejilla para Empotrar. 16 x 16 cm Ventilation Grid to embed. 16 x 16 cm .....	90
Rejilla con Persiana. 17 x 17 cm Adjustable and Closable Ventilation Grid. Square 17 x 17 cm .....	91
Rejilla con Persiana. 17 x 24,5 cm Adjustable and Closable Ventilation Grid. Square 17 x 24.5 cm .....	91
Rejilla con Mosquitera Ventilation Grids with Mosquito Net .....	92
Rejilla Horizontal Pequeña Small Horizontal Ventilation Grid .....	94
Conjunto Horizontal Pequeño Set of Small Horizontal Ventilation Grid .....	94
Rejilla Horizontal Mediana Medium Horizontal Ventilation Grid .....	94
Conjunto Horizontal Mediano Set of Medium Horizontal Ventilation Grid .....	95
Rejilla "Shunt" "Shunt" Ventilation Grid .....	95
Conjunto "Shunt" "Shunt" Set .....	95
Rejilla Circular Circular Ventilation Grid .....	96
Conjunto Circular Set of Circular Ventilation Grid .....	96
Rejilla Universal Circular con Mosquitera Circular Universal Grid with mosquito net .....	96



**Rejilla Cuadrada. 10 x 10 cm**

Rejilla de ventilación fabricada en aluminio.  
Incluye orificios para su colocación con tornillos.  
Superficie de aireación: 10 cm<sup>2</sup>

**Ventilation Grid. Square 10 x 10 cm**

Aluminium ventilation grid.  
Includes holes for fixing with screws.  
Aeration surface: 10 cm<sup>2</sup>

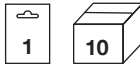
**Bolsa display / Display-bag**

Ref.	Acabado Finish	Espesor Thickness	Código Barras Bar Code
B70210A	Aluminio Aluminium	0,6 mm	8421196109759
B70210D	Lacado Blanco White Lacquered	0,8 mm	8421196109766

**Granel / Bulk**

Ref.	Acabado Finish	Espesor Thickness	Código Barras Bar Code
B70215A	Aluminio Aluminium	0,6 mm	8421196101074
B70215D	Lacado Blanco White Lacquered	0,8 mm	8421196101098

**Rejilla Cuadrada. 15 x 15 cm**

Rejilla de ventilación fabricada en aluminio.  
Incluye orificios para su colocación con tornillos.  
Superficie de aireación: 35 cm<sup>2</sup>

**Ventilation Grid. Square 15 x 15 cm**

Aluminium ventilation grid.  
Includes holes for fixing with screws.  
Aeration surface: 35 cm<sup>2</sup>

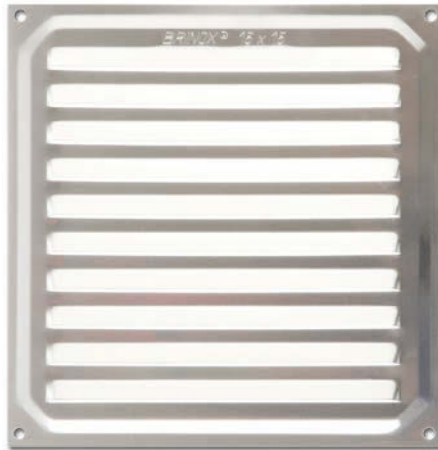
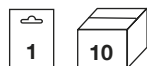
**Bolsa display / Display-bag**

Ref.	Acabado Finish	Espesor Thickness	Código Barras Bar Code
B70220A	Aluminio Aluminium	0,6 mm	8421196108950
B70220D	Lacado Blanco White Lacquered	0,8 mm	8421196108943
B70220Y	Madera Clara Clear Wood	0,6 mm	8421196108967
B70220Z	Madera Oscura Dark Wood	0,6 mm	8421196109117
B70220X	Madera Pino Pine Wood	0,6 mm	8421196109797

**Granel / Bulk**

Ref.	Acabado Finish	Espesor Thickness	Código Barras Bar Code
B70225A	Aluminio Aluminium	0,6 mm	25 8421196101159
B70225D	Lacado Blanco White Lacquered	0,8 mm	25 8421196101173
B70225Y	Madera Clara Clear Wood	0,6 mm	10 8421196101203
B70225Z	Madera Oscura Dark Wood	0,6 mm	10 8421196101210
B70225X	Madera Pino Pine Wood	0,6 mm	10 8421196107625

**Rejilla Cuadrada. 17 x 17 cm**

Rejilla de ventilación fabricada en aluminio.  
Incluye orificios para su colocación con tornillos.  
Superficie de aireación: 50 cm<sup>2</sup>

**Ventilation Grid. Square 17 x 17 cm**

Aluminium ventilation grid.  
Includes holes for fixing with screws.  
Aeration surface: 50 cm<sup>2</sup>



**Bolsa display / Display-bag**



Ref.	Acabado Finish	Espesor Thickness	Código Barras Bar Code
B70500A	Aluminio Aluminium	0,8 mm	8421196109216
B70500D	Lacado Blanco White Lacquered	0,8 mm	8421196110397
B70500Y	Madera Clara Clear Wood	0,6 mm	8421196109926
B70500Z	Madera Oscura Dark Wood	0,6 mm	8421196109933

**Granel / Bulk**

Ref.	Acabado Finish	Espesor Thickness	Icon	Código Barras Bar Code
B70505A	Aluminio Aluminium	0,8 mm	25	8421196102019
B70505D	Lacado Blanco White Lacquered	0,8 mm	25	8421196102033
B70505Y	Madera Clara Clear Wood	0,6 mm	10	8421196102064
B70505Z	Madera Oscura Dark Wood	0,6 mm	10	8421196102071

**Rejilla Cuadrada. 18 x 18 cm. 19 Aberturas**

Rejilla de ventilación fabricada en aluminio.  
Incluye orificios para su colocación con tornillos.  
Espesor: 0,8 mm  
Superficie de aireación: 132 cm<sup>2</sup>

**Ventilation Grid. Square 18 x 18 cm. 19 Slits**

Aluminium ventilation grid.  
Includes holes for fixing with screws.  
Thickness: 0.8 mm  
Aeration surface: 132 cm<sup>2</sup>



**Bolsa display / Display-bag**



Ref.	Acabado Finish	Código Barras Bar Code
B70530D	Lacado Blanco White Lacquered	8421196109063

**Granel / Bulk**



Ref.	Acabado Finish	Código Barras Bar Code
B70535D	Lacado Blanco White Lacquered	8421196108271

**Rejilla Cuadrada. 20 x 20 cm**

Rejilla de ventilación fabricada en aluminio. Incluye orificios para su colocación con tornillos. Superficie de aireación: 60 cm<sup>2</sup>

**Ventilation Grid. Square 20 x 20 cm**

Aluminium ventilation grid. Includes holes for fixing with screws. Aeration surface: 60 cm<sup>2</sup>

**Bolsa display / Display-bag**

Ref.	Acabado Finish	Espesor Thickness	Código Barras Bar Code
B70580A	Aluminio Aluminium	0,8 mm	8421196108981
B70580D	Lacado Blanco White Lacquered	0,8 mm	8421196108974
B70580Y	Madera Clara Clear Wood	0,6 mm	8421196109018
B70580Z	Madera Oscura Dark Wood	0,6 mm	8421196110359

**Granel / Bulk**

Ref.	Acabado Finish	Espesor Thickness	Icon	Código Barras Bar Code
B70585A	Aluminio Aluminium	0,8 mm	25	8421196102576
B70585D	Lacado Blanco White Lacquered	0,8 mm	25	8421196102590
B70585Y	Madera Clara Clear Wood	0,6 mm	10	8421196102620
B70585Z	Madera Oscura Dark Wood	0,6 mm	10	8421196102637

**Rejilla Cuadrada. 30 x 30 cm**

Rejilla de ventilación fabricada en aluminio. Incluye orificios para su colocación con tornillos. Superficie de aireación: 140 cm<sup>2</sup>

**Ventilation Grid. Square 30 x 30 cm**

Aluminium ventilation grid. Includes holes for fixing with screws. Aeration surface: 140 cm<sup>2</sup>

**Bolsa display / Display-bag**

Ref.	Acabado Finish	Espesor Thickness	Código Barras Bar Code
B70570A	Aluminio Aluminium	0,8 mm	8421196110618
B70570D	Lacado Blanco White Lacquered	0,8 mm	8421196110731

**Granel / Bulk**

Ref.	Acabado Finish	Espesor Thickness	Código Barras Bar Code
B70575A	Aluminio Aluminium	0,8 mm	8421196108745
B70575D	Lacado Blanco White Lacquered	0,8 mm	8421196108752





**Rejilla Cuadrada. 15 x 15 cm. Adhesiva**

Rejilla de ventilación fabricada en aluminio.  
Incluye adhesivo y orificios para su colocación con tornillos.  
Superficie de aireación: 35 cm<sup>2</sup>

**Ventilation Grid. Square 15 x 15 cm. Adhesive**

Aluminium ventilation grid.  
Includes adhesive and holes for fixing with screws.  
Aeration surface: 35 cm<sup>2</sup>



**Bolsa display / Display-bag**

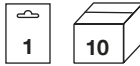

Ref.	Acabado Finish	Espesor Thickness	Código Barras Bar Code
B70350A	Aluminio Aluminium	0,6 mm	8421196111912
B70350D	Lacado Blanco White Lacquered	0,8 mm	8421196111929

**Granel / Bulk**



Ref.	Acabado Finish	Espesor Thickness	Código Barras Bar Code
B70355A	Aluminio Aluminium	0,6 mm	8421196105157
B70355D	Lacado Blanco White Lacquered	0,8 mm	8421196105164



**Rejilla Cuadrada. 17 x 17 cm. Adhesiva**

Rejilla de ventilación fabricada en aluminio.  
Incluye adhesivo y orificios para su colocación con tornillos.  
Superficie de aireación: 50 cm<sup>2</sup>

**Ventilation Grid. Square 17 x 17 cm. Adhesive**

Aluminium ventilation grid.  
Includes adhesive and holes for fixing with screws.  
Aeration surface: 50 cm<sup>2</sup>



**Bolsa display / Display-bag**

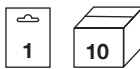

Ref.	Acabado Finish	Espesor Thickness	Código Barras Bar Code
B70510A	Aluminio Aluminium	0,8 mm	8421196109971
B70510D	Lacado Blanco White Lacquered	0,8 mm	8421196109988

**Granel / Bulk**



Ref.	Acabado Finish	Espesor Thickness	Código Barras Bar Code
B70515A	Aluminio Aluminium	0,8 mm	8421196102095
B70515D	Lacado Blanco White Lacquered	0,8 mm	8421196102118





**Rejilla Cuadrada. 18 x 18 cm. 19 Aberturas. Adhesiva**

Rejilla de ventilación fabricada en aluminio.  
Incluye adhesivo y orificios para su colocación con tornillos.  
Espesor: 0,8 mm  
Superficie de aireación: 132 cm<sup>2</sup>

**Ventilation Grid. Square 18 x 18 cm. 19 Slits. Adhesive**

Aluminium ventilation grid.  
Includes adhesive and holes for fixing with screws.  
Thickness: 0.8 mm  
Aeration surface: 132 cm<sup>2</sup>

**Bolsa display / Display-bag**

Ref.	Acabado Finish	Código Barras Bar Code
B72530D	Lacado Blanco White Lacquered	8421196116979

**Granel / Bulk**

Ref.	Acabado Finish	Código Barras Bar Code
B72535D	Lacado Blanco White Lacquered	8421196111479

**Rejilla Cuadrada. 20 x 20 cm. Adhesiva**

Rejilla de ventilación fabricada en aluminio.  
Incluye adhesivo y orificios para su colocación con tornillos.  
Espesor: 0,8 mm. Superficie de aireación: 60 cm<sup>2</sup>

**Ventilation Grid. Square 20 x 20 cm. Adhesive**

Aluminium ventilation grid.  
Includes adhesive and holes for fixing with screws.  
Thickness: 0.8 mm. Aeration surface: 60 cm<sup>2</sup>

**Bolsa display / Display-bag**

Ref.	Acabado Finish	Código Barras Bar Code
B70340A	Aluminio Aluminium	8421196111318
B70340D	Lacado Blanco White Lacquered	8421196111356

**Granel / Bulk**

Ref.	Acabado Finish	Código Barras Bar Code
B70345A	Aluminio Aluminium	8421196105072
B70345D	Lacado Blanco White Lacquered	8421196105089





**Rejilla Horizontal. 20 x 10 cm**

Rejilla de ventilación fabricada en aluminio. Incluye orificios para su colocación con tornillos. Superficie de aireación: 20 cm<sup>2</sup>

**Horizontal Ventilation Grid. 20 x 10 cm**

Aluminium ventilation grid. Includes holes for fixing with screws. Aeration surface: 20 cm<sup>2</sup>

**Bolsa display / Display-bag**

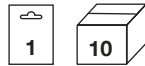

Ref.	Acabado Finish	Espesor Thickness	Código Barras Bar Code
B70230A	Aluminio Aluminium	0,8 mm	8421196109056
B70230D	Lacado Blanco White Lacquered	0,8 mm	8421196109049
B70230Z	Madera Oscura Dark Wood	0,6 mm	8421196109834



**Granel / Bulk**

Ref.	Acabado Finish	Espesor Thickness	Icon	Código Barras Bar Code
B70235A	Aluminio Aluminium	0,8 mm	25	8421196101234
B70235D	Lacado Blanco White Lacquered	0,8 mm	25	8421196101258
B70235Z	Madera Oscura Dark Wood	0,6 mm	10	8421196101296



**Rejilla Horizontal. 30 x 15 cm**

Rejilla de ventilación fabricada en aluminio. Incluye orificios para su colocación con tornillos. Superficie de aireación: 70 cm<sup>2</sup>

**Horizontal Ventilation Grid. 30 x 15 cm**

Aluminium ventilation grid. Includes holes for fixing with screws. Aeration surface: 70 cm<sup>2</sup>

**Bolsa display / Display-bag**



Ref.	Acabado Finish	Espesor Thickness	Código Barras Bar Code
B70240A	Aluminio Aluminium	0,8 mm	8421196109858
B70240D	Lacado Blanco White Lacquered	0,8 mm	8421196109131
B70240Y	Madera Clara Clear Wood	0,6 mm	8421196109865



**Granel / Bulk**

Ref.	Acabado Finish	Espesor Thickness	Icon	Código Barras Bar Code
B70245A	Aluminio Aluminium	0,8 mm	25	8421196101319
B70245D	Lacado Blanco White Lacquered	0,8 mm	25	8421196101333
B70245Y	Madera Clara Clear Wood	0,6 mm	10	8421196101364

**Rejilla Horizontal. 40 x 20 cm**

Rejilla de ventilación fabricada en aluminio.  
Incluye orificios para su colocación con tornillos.  
Espesor: 0,8 mm. Superficie de aireación: 120 cm<sup>2</sup>

**Horizontal Ventilation Grid. 40 x 20 cm**

Aluminium ventilation grid.  
Includes holes for fixing with screws.  
Thickness: 0.8 mm. Aeration surface: 120 cm<sup>2</sup>

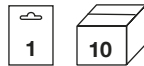
**Bolsa display / Display-bag**

Ref.	Acabado Finish	Código Barras Bar Code
B70540A	Aluminio Aluminium	8421196115422
B70540D	Lacado Blanco White Lacquered	8421196114531

**Granel / Bulk**

Ref.	Acabado Finish	Código Barras Bar Code
B70545A	Aluminio Aluminium	8421196102255
B70545D	Lacado Blanco White Lacquered	8421196102279

**Rejilla para Empotrar. 16 x 16 cm**

Rejilla de ventilación con aletas para empotrar fabricada en aluminio.  
Espesor: 0,8 mm. Superficie de aireación: 50 cm<sup>2</sup>

**Ventilation Grid to embed. 16 x 16 cm**

Aluminium ventilation grid with wings to embed.  
Thickness: 0.8 mm. Aeration surface: 50 cm<sup>2</sup>

**Bolsa display / Display-bag**

Ref.	Acabado Finish	Código Barras Bar Code
B70010A	Aluminio Aluminium	8421196109735
B70010D	Lacado Blanco White Lacquered	8421196109742

**Granel / Bulk**

Ref.	Acabado Finish	Código Barras Bar Code
B70015A	Aluminio Aluminium	8421196100633
B70015D	Lacado Blanco White Lacquered	8421196100640



**Rejilla con Persiana. 17 x 17 cm**

Rejilla de ventilación fabricada en aluminio de 0,8 mm de espesor.  
Mecanismo de cierre con persiana para poder graduar la aireación de la rejilla.  
Incluye orificios para su colocación con tornillos.  
Superficie de aireación: 70 cm<sup>2</sup>

**Adjustable and Closable Ventilation Grid. 17 x 17 cm**

Ventilation grid made of 0.8 mm thickness aluminium.  
Lock mechanism to graduate the aeration.  
Includes holes for fixing with screws.  
Aeration surface: 70 cm<sup>2</sup>



**Bolsa display / Display-bag**

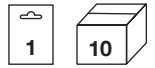

Ref.	Acabado Finish	Código Barras Bar Code
B70380A	Aluminio Aluminium	8421196107885
B70380D	Lacado Blanco White Lacquered	8421196107892

**Granel / Bulk**



Ref.	Acabado Finish	Código Barras Bar Code
B70385A	Aluminio Aluminium	8421196103863
B70385D	Lacado Blanco White Lacquered	8421196103832



**Rejilla con Persiana. 17 x 24,5 cm**

Rejilla de ventilación fabricada en aluminio de 0,8 mm de espesor.  
Mecanismo de cierre con persiana para poder graduar la aireación de la rejilla.  
Incluye orificios para su colocación con tornillos.  
Superficie de aireación: 110 cm<sup>2</sup>

**Adjustable and Closable Ventilation Grid. 17 x 24.5 cm**

Ventilation grid made of 0.8 mm thickness aluminium.  
Lock mechanism to graduate the aeration.  
Includes holes for fixing with screws.  
Aeration surface: 110 cm<sup>2</sup>



**Bolsa display / Display-bag**

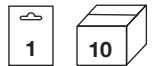

Ref.	Acabado Finish	Código Barras Bar Code
B70390A	Aluminio Aluminium	8421196109902
B70390D	Lacado Blanco White Lacquered	8421196109919



**Granel / Bulk**



Ref.	Acabado Finish	Código Barras Bar Code
B70395A	Aluminio Aluminium	8421196105935
B70395D	Lacado Blanco White Lacquered	8421196105676



**Rejilla de ventilación con Mosquitera**

Rejilla de ventilación fabricada en aluminio.  
Incluye orificios para su colocación con tornillos.  
Malla mosquitera de Fibra de vidrio laminado.  
Paso de malla: 1,4 mm. Espesor de malla: 0,29 mm  
Resistencia a la temperatura: -25 a 120 °C  
Resistencia al fuego: Categoría M2 (norma UNE 23727)

**Ventilation Grid with Mosquito Net**

Ventilation grid made of aluminium.  
Includes holes for fixing with screws.  
Mosquito net made of Laminated fibreglass.  
Mesh step: 1.4 mm. Mesh thickness: 0.29 mm  
Temperature resistance: -25 to 120 °C  
Fire resistance: M2 category (UNE 23727)

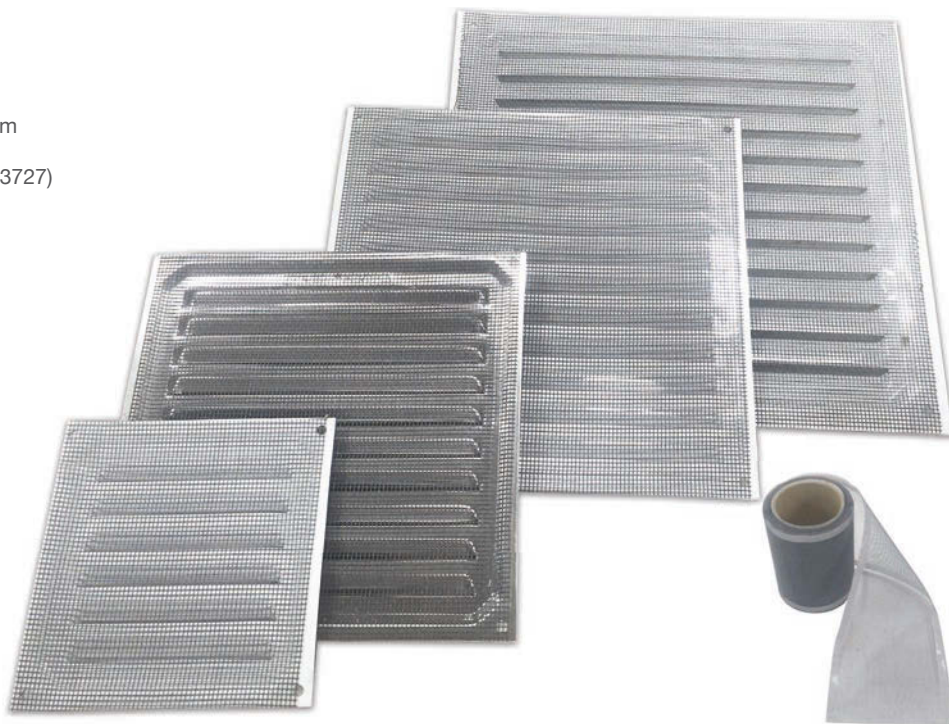
**Rejilla de ventilación con Mosquitera. 10 x 10 cm**

Superficie de aireación: 10 cm<sup>2</sup>

**Ventilation Grid with Mosquito Net. 10 x 10 cm**

Aeration surface: 10 cm<sup>2</sup>

**Bolsa display / Display-bag**

Ref.	Acabado Finish	Espesor Thickness	Código Barras Bar Code
B73000A	Aluminio Aluminium	0,6 mm	8421196124295
B73000D	Lacado Blanco White Lacquered	0,8 mm	8421196124301

**Granel / Bulk**

Ref.	Acabado Finish	Espesor Thickness	Código Barras Bar Code
B73005A	Aluminio Aluminium	0,6 mm	8421196124196
B73005D	Lacado Blanco White Lacquered	0,8 mm	8421196124202

**Rejilla de ventilación con Mosquitera. 15 x 15 cm**

Superficie de aireación: 35 cm<sup>2</sup>

**Ventilation Grid with Mosquito Net. 15 x 15 cm**

Aeration surface: 35 cm<sup>2</sup>

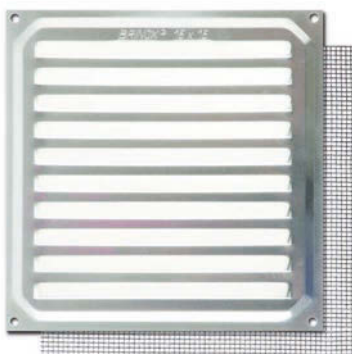
**Bolsa display / Display-bag**

Ref.	Acabado Finish	Espesor Thickness	Código Barras Bar Code
B73010A	Aluminio Aluminium	0,6 mm	8421196124318
B73010D	Lacado Blanco White Lacquered	0,8 mm	8421196124325

**Granel / Bulk**

Ref.	Acabado Finish	Espesor Thickness	Código Barras Bar Code
B73015A	Aluminio Aluminium	0,6 mm	8421196124219
B73015D	Lacado Blanco White Lacquered	0,8 mm	8421196124226

**Rejilla de ventilación con Mosquitera. 17 x 17 cm**

Espesor: 0,8 mm. Superficie de aireación: 50 cm<sup>2</sup>

**Ventilation Grid with Mosquito Net. 17 x 17 cm**

Thickness: 0.8 mm. Aeration surface: 50 cm<sup>2</sup>



**Bolsa display / Display-bag**

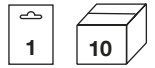

Ref.	Acabado Finish	Código Barras Bar Code
B73020A	Aluminio Aluminium	8421196124332
B73020D	Lacado Blanco White Lacquered	8421196124349

**Granel / Bulk**



Ref.	Acabado Finish	Código Barras Bar Code
B73025A	Aluminio Aluminium	8421196124233
B73025D	Lacado Blanco White Lacquered	8421196124240

**Rejilla de ventilación con Mosquitera. 20 x 20 cm**

Espesor: 0,8 mm. Superficie de aireación: 60 cm<sup>2</sup>

**Ventilation Grid with Mosquito Net. 20 x 20 cm**

Thickness: 0.8 mm. Aeration surface: 60 cm<sup>2</sup>



**Bolsa display / Display-bag**

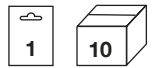

Ref.	Acabado Finish	Código Barras Bar Code
B73040A	Aluminio Aluminium	8421196124356
B73040D	Lacado Blanco White Lacquered	8421196124363

**Granel / Bulk**



Ref.	Acabado Finish	Código Barras Bar Code
B73045A	Aluminio Aluminium	8421196124257
B73045D	Lacado Blanco White Lacquered	8421196124264

**Rejilla de ventilación con Mosquitera. 30 x 30 cm**

Espesor: 0,8 mm. Superficie de aireación: 140 cm<sup>2</sup>

**Ventilation Grid with Mosquito Net. 30 x 30 cm**

Thickness: 0.8 mm. Aeration surface: 140 cm<sup>2</sup>



**Bolsa display / Display-bag**

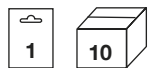

Ref.	Acabado Finish	Código Barras Bar Code
B73050A	Aluminio Aluminium	8421196126015
B73050D	Lacado Blanco White Lacquered	8421196126022

**Granel / Bulk**



Ref.	Acabado Finish	Código Barras Bar Code
B73055A	Aluminio Aluminium	8421196124271
B73055D	Lacado Blanco White Lacquered	8421196124288

**Rejilla Horizontal Pequeña**

Rejilla de ventilación fabricada en ABS.  
Tamaño: 270 x 105 mm  
Superficie de aireación: 72 cm<sup>2</sup>

**Small Horizontal Ventilation Grid**

ABS Plastic ventilation grid.  
Size: 270 x 105 mm  
Aeration surface: 72 cm<sup>2</sup>



Ref.	Acabado Finish	Código Barras Bar Code
B72605B	Blanco White	8421196114647

**Conjunto Horizontal Pequeño**

Conjunto de rejilla de ventilación y mosquitera  
fabricada en ABS.  
Tamaño: 270 x 105 mm  
Superficie de aireación: 72 cm<sup>2</sup>

**Set of Small Horizontal Ventilation Grid**

Set of ventilation grid and mosquito net in ABS plastic.  
Size: 270 x 105 mm  
Aeration surface: 72 cm<sup>2</sup>

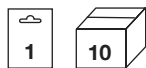

Ref.	Acabado Finish	Código Barras Bar Code
B72620B	Blanco White	8421196114685

**Rejilla Horizontal Mediana**

Rejilla de ventilación fabricada en ABS.  
Tamaño: 270 x 170 mm  
Superficie de aireación: 145 cm<sup>2</sup>

**Medium Horizontal Ventilation Grid**

ABS Plastic ventilation grid.  
Size: 270 x 170 mm  
Aeration surface: 145 cm<sup>2</sup>



Ref.	Acabado Finish	Código Barras Bar Code
B72635B	Blanco White	8421196114760





**Conjunto Horizontal Mediano**

Conjunto de rejilla de ventilación y mosquitera fabricado en ABS.  
Tamaño: 270 x 170 mm  
Superficie de aireación: 145 cm<sup>2</sup>

**Set of Medium Horizontal Ventilation Grid**

Set of ventilation grid and mosquito net in ABS plastic.  
Size: 270 x 170 mm  
Aeration surface: 145 cm<sup>2</sup>

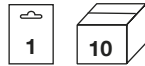

Ref.	Acabado Finish	Código Barras Bar Code
B72650B	Blanco White	8421196114722

**Rejilla "Shunt"**

Rejilla para conducto "Shunt" para ventilación de baños y aseos. Fabricada en Polipropileno y Poliestireno de alto impacto. Tamaño: 140 x 240 mm  
Superficie de aireación: 102 cm<sup>2</sup>

**"Shunt" Ventilation Grid**

Ventilation grid for shunt bathroom conducts. Made of polypropylene and high impact polystyrene. Size: 140 x 240 mm  
Aeration surface: 102 cm<sup>2</sup>



**Conjunto "Shunt"**

Rejilla para baños y aseos para conducto "Shunt" de ventilación. Incluye marco para encastrar y mosquitera. Fabricada en Polipropileno y Poliestireno de alto impacto. Tamaño: 140 x 240 mm  
Superficie de aireación: 102 cm<sup>2</sup>

**"Shunt" Set**

Ventilation Grid Shunt for bathrooms and toilets. Includes frame and mosquito net. Made of polypropylene and high impact polystyrene. Size: 140 x 240 mm  
Aeration surface: 102 cm<sup>2</sup>



Ref.	Acabado Finish	Código Barras Bar Code
B70595B	Blanco White	8421196102651



Ref.	Acabado Finish	Código Barras Bar Code
B70980B	Blanco White	8421196108028

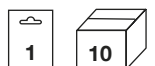



**Rejilla Circular**

Rejilla circular de plástico ABS.  
Tamaño: Ø 150 mm  
Superficie de aireación: 100 cm<sup>2</sup>

**Circular Ventilation Grid**

Circular ventilation grid in high-impact polystyrene.  
Size: Ø 150 mm  
Aeration surface: 100 cm<sup>2</sup>



Ref.	Acabado Finish		Código Barras Bar Code
B70950B	Blanco White	1	8421196126176
B70955B	Blanco White	x	8421196111301

**Conjunto Circular**

Conjunto de rejilla circular y mosquitera de plástico ABS.  
Tamaño: Ø 150 mm  
Superficie de aireación: 100 cm<sup>2</sup>

**Set of Circular Ventilation Grid**

Set of circular ventilation grid and mosquito net in high-impact polystyrene.  
Size: Ø 150 mm  
Aeration surface: 100 cm<sup>2</sup>



Ref.	Acabado Finish	Código Barras Bar Code
B70970B	Blanco White	8421196111363

**Rejilla Universal Circular con Mosquitera**

Rejilla universal circular con mosquitera de ABS.  
Tamaño: Ø 100 ~ 130 mm  
Superficie de aireación: 100 cm<sup>2</sup>

**Circular Universal Grid with mosquito net**

Universal round grid with mosquito net in high-impact polystyrene.  
Size: Ø 100 ~ 130 mm  
Aeration surface: 100 cm<sup>2</sup>



Ref.	Acabado Finish	Código Barras Bar Code
B72700B	Blanco White	8421196124455

# Burletes para Puertas y Ventanas

## Weatherstrips for doors and windows



Burlete Bajo Puerta <i>Under Door Weatherstrip</i> .....	98
Burlete Suelo Desnivelado <i>Weatherstrip for Uneven Floor</i> .....	99
Burlete Cepillo Curvado <i>Curved Weatherstrip with Brush</i> .....	100
Burlete Curvado <i>Curved Weatherstrip</i> .....	101
Burlete Goma Bajo Puerta <i>Rubber Weatherstrip</i> .....	102
Burlete Aluminio con Pelo <i>Aluminium Weatherstrip with Brush</i> .....	103
Burlete Aluminio con Goma <i>Aluminium Weatherstrip with Rubber</i> .....	103
Burlete Autoadhesivo de PVC Expandido para Bajos de Puertas <i>Weatherstrip. Expanded self-adhesive PVC</i> .....	104
Burlete de Goma para puertas de garaje <i>Rubber Weatherstrip for Garage Doors</i> .....	104
Burlete para Puertas y Ventanas. Tipo "E" <i>EPDM Weatherstrip. Type "E"</i> .....	105
Burlete para Puertas y Ventanas. Tipo "P" <i>EPDM Weatherstrip. Type "P"</i> .....	105
Burlete para Puertas y Ventanas. Tipo "D" <i>EPDM Weatherstrip. Type "D"</i> .....	105
Burlete Silicona para Puertas y Ventanas <i>Silicone Weatherstrip for Doors and Windows</i> .....	106
Burlete de PVC para Puertas y Ventanas <i>PVC Draught Excluder for Doors and Windows</i> .....	106



**Burlete Bajo Puerta**

Burlete fabricado en PVC y pelo de 13 mm de altura con lámina de estanqueidad de plástico. Adhesivo de alta calidad.

**Under Door Weatherstrip**

PVC weatherstrip. 13 mm height brush. Waterproof plastic blade. High quality adhesive.

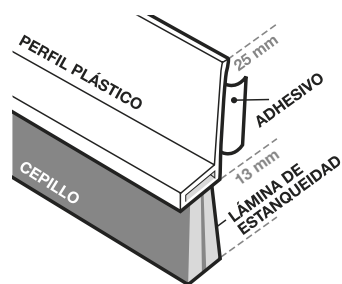

Ref.	Longitud Length	Código Barras Bar Code
B80200B	82 cm	8421196103993
B80210B	100 cm	8421196104013

Ref.	Longitud Length	Código Barras Bar Code
B80200M	82 cm	8421196104006
B80210M	100 cm	8421196104020

Ref.	Longitud Length	Código Barras Bar Code
B80200G	82 cm	8421196104402
B80210G	100 cm	8421196104440





### Burlete Suelo Desnivelado

Burlete fabricado en PVC y pelo de 15 mm de altura con lámina de estanqueidad de plástico. Adhesivo de alta calidad.

### Weatherstrip for Uneven Floor

PVC weatherstrip. 15 mm height brush. Waterproof plastic blade. High quality adhesive.

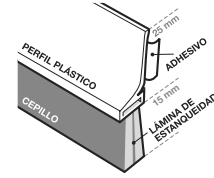

Blanco · White

Negro · Black

Marrón · Brown

Madera Clara · Clear Wood

Madera Oscura · Dark Wood

Madera Pino · Pine Wood

Trasparente · Transparent

Ref.	Longitud Length	Código Barras Bar Code
B82210B	100 cm	8421196115613

Ref.	Longitud Length	Código Barras Bar Code
B82210N	100 cm	8421196125865

Ref.	Longitud Length	Código Barras Bar Code
B82210M	100 cm	8421196115620

Ref.	Longitud Length	Código Barras Bar Code
B82210Y	100 cm	8421196115644

Ref.	Longitud Length	Código Barras Bar Code
B82210Z	100 cm	8421196115651

Ref.	Longitud Length	Código Barras Bar Code
B82210X	100 cm	8421196115637

Ref.	Longitud Length	Código Barras Bar Code
B82200H	82 cm	8421196116436
B82210H	100 cm	8421196116443







### Burlete Cepillo Curvado

Burlete fabricado en PVC y cepillo de 25 mm de altura. Adhesivo de alta calidad.

### Curved Weatherstrip with Brush

PVC weatherstrip. 25 mm height brush. Waterproof plastic blade. High quality adhesive.

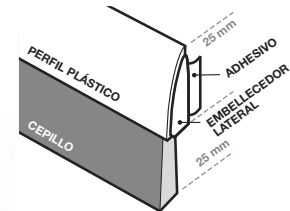

Ref.	Longitud Length	Código Barras Bar Code
B80350B	100 cm	8421196109667

Ref.	Longitud Length	Código Barras Bar Code
B80350M	100 cm	8421196109674

Ref.	Longitud Length	Código Barras Bar Code
B80350Y	100 cm	8421196109681

Ref.	Longitud Length	Código Barras Bar Code
B80350Z	100 cm	8421196109698



### Burlete Curvado

Burlete fabricado en PVC y pelo de 13 mm de altura con lámina de estanqueidad de plástico. Adhesivo de alta calidad.

### Curved Weatherstrip

PVC weatherstrip. 13 mm height brush. Waterproof plastic blade. High quality adhesive.

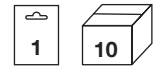
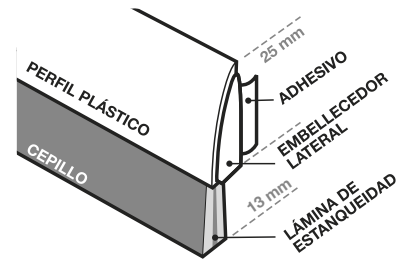

Ref.	Longitud Length	Código Barras Bar Code
B80320B	82 cm	8421196103184
B80330B	100 cm	8421196103238

Ref.	Longitud Length	Código Barras Bar Code
B80320M	82 cm	8421196103191
B80330M	100 cm	8421196103245

Ref.	Longitud Length	Código Barras Bar Code
B80320Y	82 cm	8421196103221
B80330Y	100 cm	8421196103252

Ref.	Longitud Length	Código Barras Bar Code
B80320Z	82 cm	8421196106109
B80330Z	100 cm	8421196106116

Ref.	Longitud Length	Código Barras Bar Code
B80320X	82 cm	8421196106833
B80330X	100 cm	8421196106840





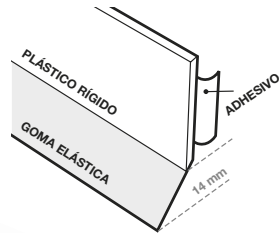

### Burlete Goma Bajo Puerta

Burlete fabricado de perfil bicomponente extrusionado en cuerpo de PVC rígido y semi-rígido de 14 mm de altura. Adhesivo de alta calidad.

### Rubber Weatherstrip

Bi-component weatherstrip, made of extruded rigid and semi-rigid PVC body. 14 mm height. High quality adhesive.

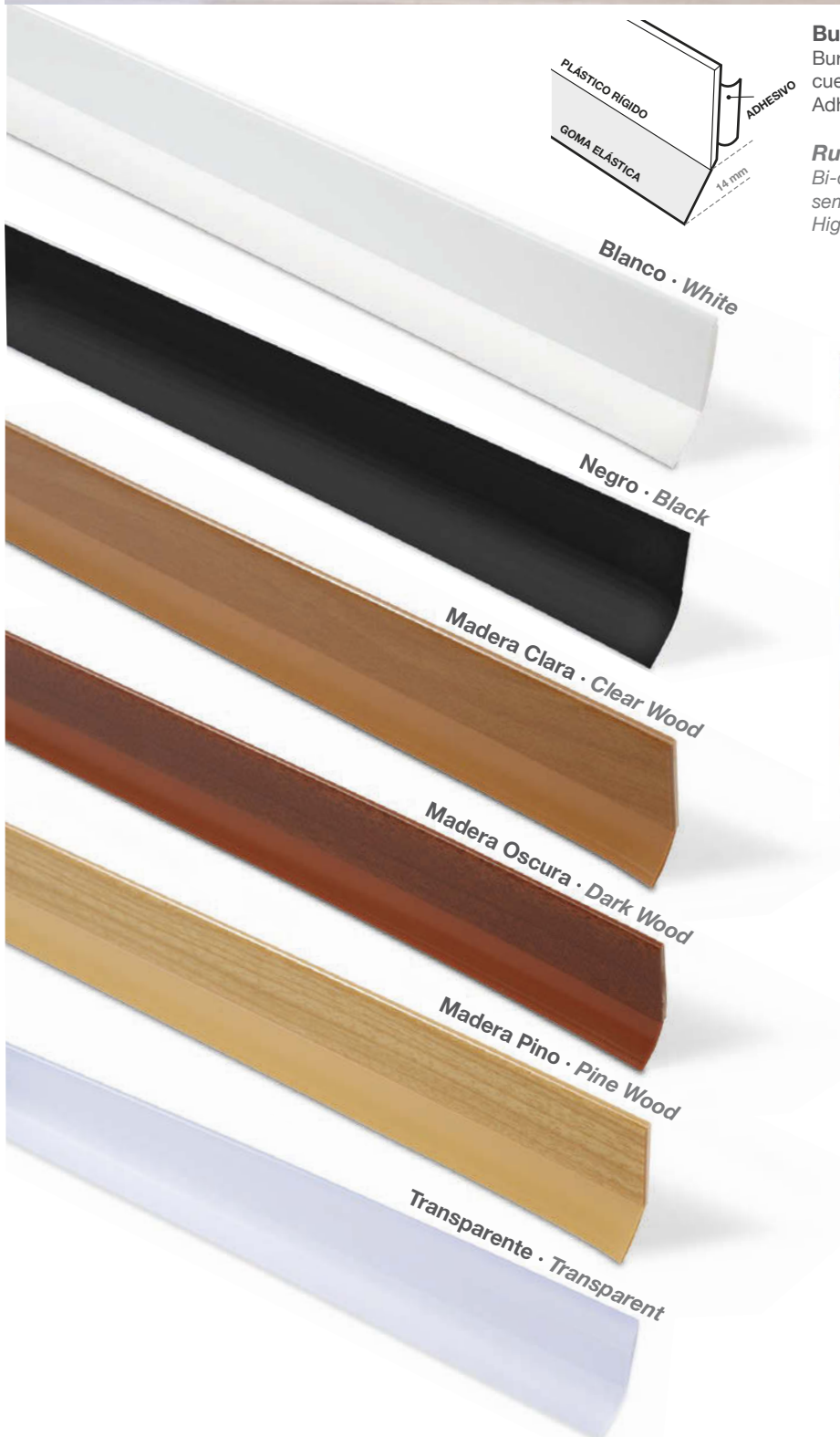
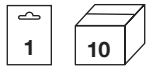

Ref.	Longitud Length	Código Barras Bar Code
B80270B	82 cm	8421196104136
B80280B	100 cm	8421196104150

Ref.	Longitud Length	Código Barras Bar Code
B80280N	100 cm	8421196125858

Ref.	Longitud Length	Código Barras Bar Code
B80270Y	82 cm	8421196115101
B80280Y	100 cm	8421196115118

Ref.	Longitud Length	Código Barras Bar Code
B80270Z	82 cm	8421196104143
B80280Z	100 cm	8421196104167

Ref.	Longitud Length	Código Barras Bar Code
B80270X	82 cm	8421196115064
B80280X	100 cm	8421196115071

Ref.	Longitud Length	Código Barras Bar Code
B80270H	82 cm	8421196117334
B80280H	100 cm	8421196117341

### Burlete Aluminio con Pelo

Burlete fabricado en aluminio.  
Pelo de 25 mm. Adhesivo de alta calidad.  
Longitud: 100 cm

**Aluminium Weatherstrip with Brush**  
Weatherstrip made of aluminium.  
25 mm height brush. High quality adhesive.  
Length: 100 cm

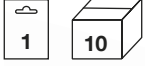

Ref.	Acabado Finish	Código Barras Bar Code
B82700D	Blanco White	8421196126053
B82700A	Aluminio Aluminium	8421196126039
B82700E	Inoxidable Stainless	8421196126046
B82700M	Marrón Brown	8421196126060
B82700N	Negro Black	8421196126077



### Burlete Aluminio con Goma

Burlete fabricado en aluminio.  
Goma de 25 mm. Adhesivo de alta calidad.  
Longitud: 100 cm

**Aluminium Weatherstrip with Rubber**  
Weatherstrip made of aluminium.  
25 mm height rubber. High quality adhesive.  
Length: 100 cm

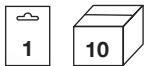

Ref.	Acabado Finish	Código Barras Bar Code
B82720D	Blanco White	8421196126107
B82720A	Aluminio Aluminium	8421196126084
B82720E	Inoxidable Stainless	8421196126091
B82720M	Marrón Brown	8421196126114
B82720N	Negro Black	8421196126121

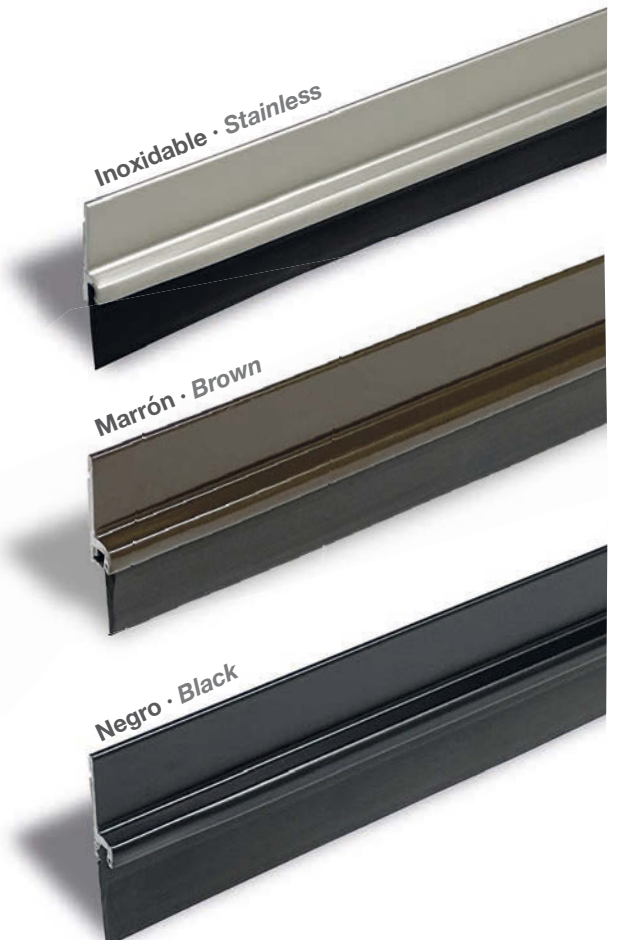



### Burlete Autoadhesivo de PVC Expandido para Bajos de Puertas

Burlete fabricado en PVC expandido.  
Adhesivo acrílico.  
Ancho 38 mm  
Longitud 100 cm

**Weatherstrip. Expanded self-adhesive PVC.**  
Weatherstrip built in expanded PVC foam.  
Acrylic adhesive.  
Width 38 mm  
Length 100 cm



Ref.	Color Colour	Código Barras Bar Code
B82220B	Blanco White	8421196118119
B82220M	Marrón Brown	8421196118126



### Burlete de Goma para puertas de garaje

Burlete adhesivo de goma extrusionado idóneo para puertas de garaje. Adhesivo de alta calidad.

#### Rubber Weatherstrip for Garage Doors. Adhesive

Door seal made of extruded rubber for garage doors.  
High quality adhesive.



Ref.	Longitud Length	Código Barras Bar Code
B82650N	2,5 m	8421196123465
B82660N	5 m	8421196123472



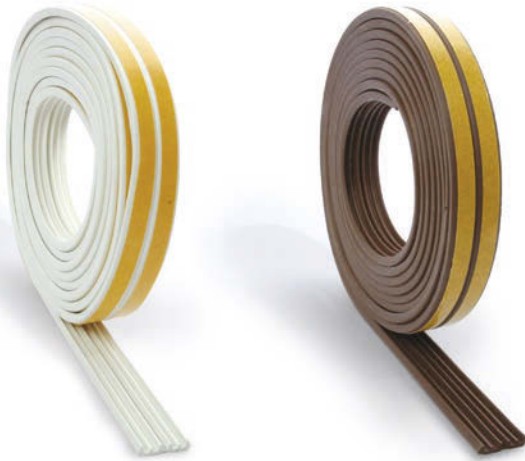

**Burlete para Puertas y Ventanas. Tipo "E"**

Burlete fabricado en caucho EPDM de alto nivel aislante. Forma "E". Para rendijas de 1 a 3,5 mm. Tamaño: 9 x 4 mm



**EPDM Weatherstrip. Type "E"**

EPDM Weatherstrip for Doors and Windows. High insulation level. Type "E". For joints from 1 to 3.5 mm. Size: 9 x 4 mm

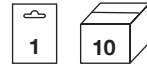

Ref.	Color Colour	Longitud Length	Código Barras Bar Code
B82500B	Blanco White	6 m	8421196116702
B82500M	Marrón Brown		8421196116719
B82450B	Blanco White	24 m	8421196125919
B82450M	Marrón Brown		8421196125926



**Burlete para Puertas y Ventanas. Tipo "P"**

Burlete fabricado en caucho EPDM de alto nivel aislante. Forma "P" con cámara de aire interior. Para rendijas de 2 a 5 mm. Tamaño: 9 x 5,5 mm



**EPDM Weatherstrip. Type "P"**

EPDM Weatherstrip. High insulation level. "P" shape with internal inner tube. For joints from 2 to 5 mm. Size: 9 x 5.5 mm

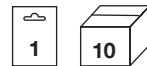

Ref.	Color Colour	Longitud Length	Código Barras Bar Code
B82510B	Blanco White	6 m	8421196116726
B82510M	Marrón Brown		8421196116733
B82460B	Blanco White	24 m	8421196125933
B82460M	Marrón Brown		8421196125940

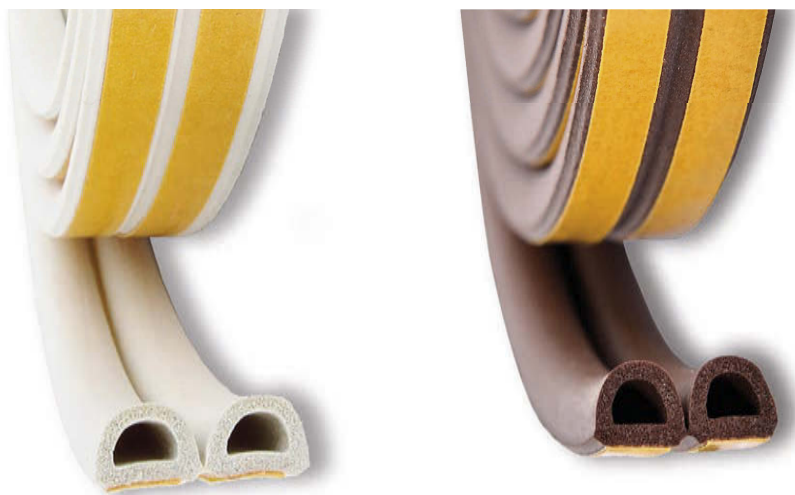

**Burlete para Puertas y Ventanas. Tipo "D"**

Burlete fabricado en caucho EPDM de alto nivel aislante. Forma "D" con cámara de aire interior. Para rendijas de 2 a 5,5 mm. Tamaño: 9 x 6 mm. Longitud: 6 m

**EPDM Weatherstrip. Type "D"**

EPDM Weatherstrip. High insulation level. "D" shape with internal inner tube. For joints from 2 to 5.5 mm. Size: 9 x 6 mm. Length: 6 m



Ref.	Color Colour	Código Barras Bar Code
B82520B	Blanco White	8421196125155
B82520M	Marrón Brown	8421196125162

### Burlete Silicona para Puertas y Ventanas

Burlete fabricado en silicona de alto nivel elástico.  
Para rendijas de 1 a 7 mm  
Tamaño: 7 x 9 mm  
Longitud: 6 m

### Silicone Weatherstrip for Doors and Windows

Seal made of high elastic silicone.  
For joints from 1 to 7 mm  
Size: 7 x 9 mm  
Length: 6 m



Economizador. Evita pérdidas energéticas de aire acondicionado en verano.  
Economizer. Prevents energy losses of airconditioning in summer.



Resistente a los Rayos Ultravioletas.  
Resistant to Ultraviolet rays.



Apto para puertas y ventanas.  
Suitable for doors and windows.



Impermeable  
Waterproof



Resistente a la intemperie.  
Resistant to the elements.



Aislante térmico para invierno.  
Thermal insulation for winter.



Ref.	Color Colour	Código Barras Bar Code
B82550B	Blanco White	8421196120082
B82550M	Marrón Brown	8421196120099
B82550H	Transparente Transparent	8421196120105



### Burlete de PVC para Puertas y Ventanas

Burlete de espuma y PVC.  
Color: Blanco  
Longitud: 15 m

### PVC Weatherstrip for Doors and Windows

PVC and foam weatherstrip.  
Colour: White  
Length: 15 m



Ref.	Tamaño Length	Código Barras Bar Code
B80290B	4 x 12 mm	8421196120082
B80310B	4 x 7 mm	8421196120099



# Canaleta Eléctrica

## Cable Trunking

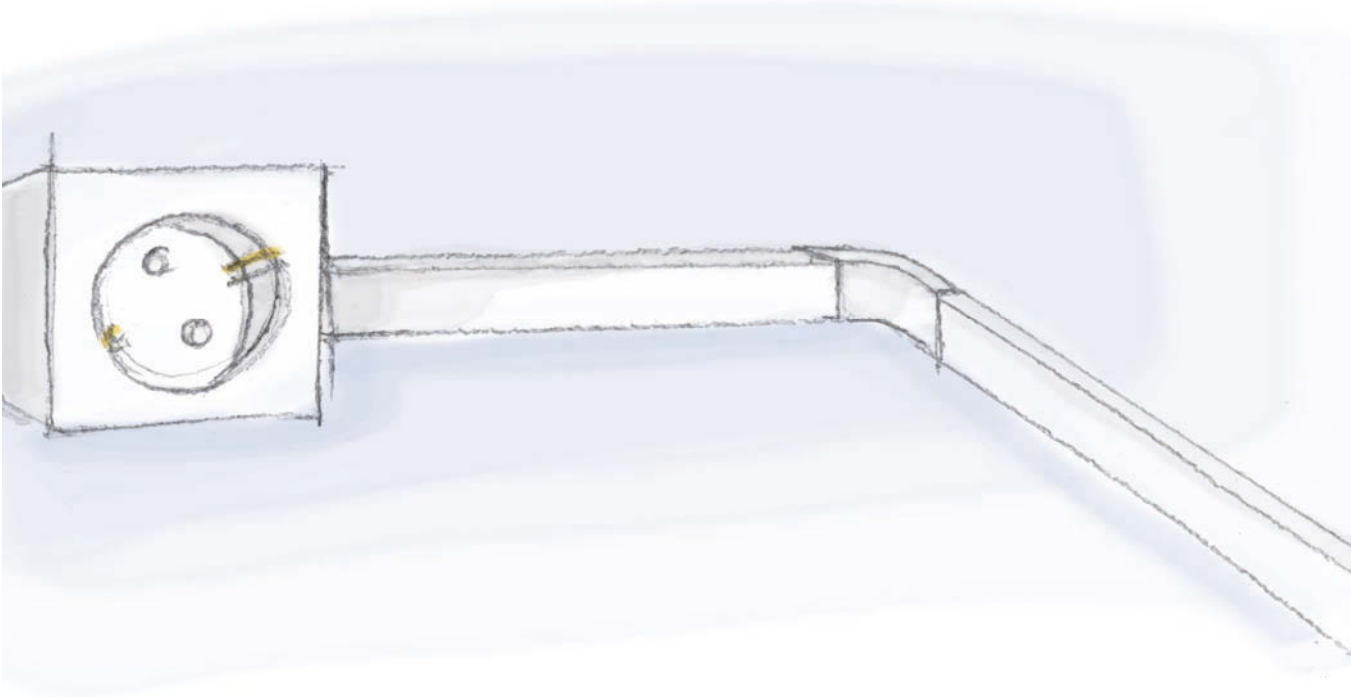

Canal Protector Pequeño <i>Small Cable Trunking</i> .....	108
Uniones Surtidas Pequeñas <i>Small Cable Trunking Connectors</i> .....	108
Canal Protector Mediano <i>Medium Cable Trunking</i> .....	109
Uniones Surtidas Medianas <i>Medium Cable Trunking Connectors</i> .....	109
Canal Protector Grande <i>Large Cable Trunking</i> .....	110
Canal Protector Industrial <i>Industrial Cable Trunking</i> .....	110





**Canal Protector Pequeño**

Canal para instalaciones de una pieza con tapa fabricado en PVC. Adhesivo de alta calidad. Tamaño: 11 x 9 mm

**Small Cable Trunking**

Cable trunking in one PVC piece, with a lid to hide the wires. High quality adhesive. Size: 11 x 9 mm

**Longitud 1 m / Length 1 m \***

Ref.	Acabado Finish	Código Barras Bar Code
B60600B	Blanco White	8421196106123

\* Incluye accesorios de unión  
\* Union pieces included



**Longitud 2 m / Length 2 m**

Ref.	Acabado Finish	Código Barras Bar Code
B60635B	Blanco White	8421196117853
B60635Y	Madera Clara Clear Wood	8421196117877
B60635Z	Madera Oscura Dark Wood	8421196117884



**Longitud 2,5 m / Length 2.5 m**

Ref.	Acabado Finish	Código Barras Bar Code
B60615B	Blanco White	8421196107069



**Uniones Surtidas Pequeñas**

Accesorios para unión de canal pequeño. Presentación: Display con 5 accesorios: unión recta, unión codo plano, unión para rincones, unión para esquinas y unión triple en T.

**Small Cable Trunking Connectors**

Connectors for small trunking. Packaging with 5 accessories: straight union, flat angle union, angle union, corner union, and T union pieces.



Ref.	Color Colour	Código Barras Bar Code
B60640B	Blanco White	8421196117365

### Canal Protector Mediano

Canal para instalaciones de una pieza con tapa fabricado en PVC.  
Adhesivo de alta calidad.  
Tamaño: 18 x 11 mm

### Medium Cable Trunking

Cable trunking in one PVC piece, with a lid to hide the wires.

High quality adhesive.  
Size: 18 x 11 mm

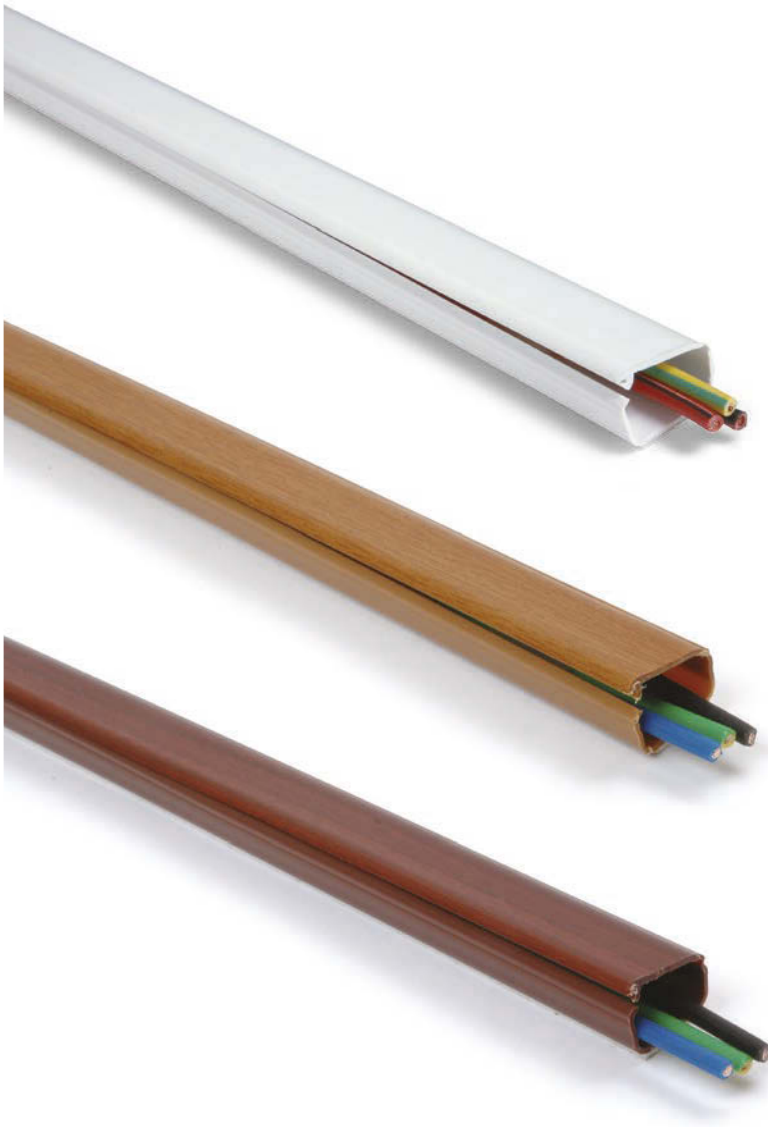

### Longitud 1 m / Length 1 m \*

Ref.	Acabado Finish	Código Barras Bar Code
B60700B	Blanco White	8421196107908

\* Incluye accesorios de unión  
\* Union pieces included

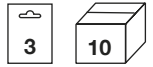

### Longitud 2 m / Length 2 m

Ref.	Acabado Finish	Código Barras Bar Code
B60735B	Blanco White	8421196117891
B60735Y	Madera Clara Clear Wood	8421196117914
B60735Z	Madera Oscura Dark Wood	8421196117921



### Longitud 2,5 m / Length 2.5 m

Ref.	Acabado Finish	Código Barras Bar Code
B60715B	Blanco White	8421196108905



### Uniones Surtidas Medianas

Accesorios para unión de canal mediano.  
Presentación: Display con 5 accesorios: unión recta, unión codo plano, unión para rincones, unión para esquinas y unión triple en T.



### Medium Cable Trunking Connectors

Connectors for medium trunking.  
Packaging with 5 accessories: straight union, flat angle union, angle union, corner union, and T union pieces.

Ref.	Color Colour	Código Barras Bar Code
B60740B	Blanco White	8421196117396



**Canal Protector Grande**

Canal para instalaciones de una pieza con tapa fabricado en PVC. Adhesivo de alta calidad.  
Tamaño: 23 x 13 mm

**Large Cable Trunking**

Cable trunking in one PVC piece, with a lid to hide the wires. High quality adhesive.  
Size: 23 x 13 mm

**Longitud 1 m / Length 1 m**

Ref.	Acabado Finish	Código Barras Bar Code
B60800B	Blanco White	8421196108721

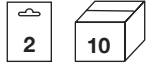
**Longitud 2 m / Length 2 m**

Ref.	Acabado Finish	Código Barras Bar Code
B60835B	Blanco White	8421196117938
B60835Y	Madera Clara Clear Wood	8421196117952
B60835Z	Madera Oscura Dark Wood	8421196117969

**Longitud 2,5 m / Length 2.5 m**

Ref.	Acabado Finish	Código Barras Bar Code
B60815B	Blanco White	8421196108936

**Canal Protector Industrial**

Canal para instalaciones de una pieza con tapa fabricado en PVC. Adhesivo de alta calidad.  
Tamaño: 28 x 15 mm

**Industrial Cable Trunking**

Cable trunking in one PVC piece, with a lid to hide the wires. High quality adhesive.  
Size: 28 x 15 mm

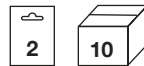
**Longitud 1 m / Length 1 m**

Ref.	Acabado Finish	Código Barras Bar Code
B60900B	Blanco White	8421196116153

**Longitud 2 m / Length 2 m**

Ref.	Acabado Finish	Código Barras Bar Code
B60935B	Blanco White	8421196117976

**Longitud 2,5 m / Length 2.5 m**

Ref.	Acabado Finish	Código Barras Bar Code
B60915B	Blanco White	8421196116481



# Ángulos

## Corner Guards

Ángulos Metálicos Adhesivos <i>Metallic Corner Guard with Adhesive</i> .....	112
Ángulos Metálicos Sin Adhesivo <i>Metallic Corner Guard without Adhesive</i> .....	113
Ángulos PVC Adhesivos <i>Corner Guard PVC Adhesive</i> .....	114
Ángulos MDF <i>Corner Guard MDF</i> .....	115
Cubre Esquinas y Rincones <i>Corner Guard</i> .....	116





**Ángulos Metálicos Adhesivos**

Ángulos metálicos con adhesivo para protección de esquinas.  
Longitud: 2,5 m

**Metallic Corner Guard with Adhesive**

Adhesive metal angles for corner protection.  
Length: 2.5 m

**Perfil 15 x 15 mm / Section 15 x 15 mm**

Ref.	Acabado Finish	Espesor Thickness	Código Barras Bar Code
B84075E	Acero Inoxidable Stainless Steel	0,6 mm	8421196125896
B84075D	Lacado Blanco White Lacquered	1,0 mm	8421196126008

**Perfil 20 x 20 mm / Section 20 x 20 mm**

Ref.	Acabado Finish	Espesor Thickness	Código Barras Bar Code
B801356	Acero Inoxidable Stainless Steel	0,6 mm	8421196103887
B803656	Lacado Blanco White Lacquered	1,0 mm	8421196110809
B806256	Aluminio Aluminium	1,0 mm	8421196113268
B807256	Madera Clara Clear Wood	0,6 mm	8421196113282
B808256	Madera Oscura Dark Wood	0,6 mm	8421196113312
B809256	Madera Pino Pine Wood	0,6 mm	8421196115835

**Perfil 25 x 25 mm / Section 25 x 25 mm**

Ref.	Acabado Finish	Espesor Thickness	Código Barras Bar Code
B801556	Acero Inoxidable Stainless Steel	0,6 mm	8421196103948
B801656	Latón Brass	0,8 mm	8421196103979
B803756	Lacado Blanco White Lacquered	1,0 mm	8421196110816
B806356	Aluminio Aluminium	1,0 mm	8421196101302
B807356	Madera Clara Clear Wood	0,6 mm	8421196113299
B808356	Madera Oscura Dark Wood	0,6 mm	8421196113329
B809356	Madera Pino Pine Wood	0,6 mm	8421196115842

**Perfil 30 x 30 mm / Section 30 x 30 mm**

Ref.	Acabado Finish	Espesor Thickness	Código Barras Bar Code
B803856	Lacado Blanco White Lacquered	1,5 mm	8421196115828
B805156	Acero Inoxidable Stainless Steel	0,6 mm	8421196115941



### Ángulos Metálicos Sin Adhesivo

Ángulos metálicos para protección de esquinas.  
Longitud: 2,5 m

#### *Metallic Corner Guard without Adhesive*

*Metal angles for corner protection.*  
*Length: 2.5 m*



#### Perfil 15 x 15 mm / Section 15 x 15 mm

Ref.	Acabado Finish	Espesor Thickness	Código Barras Bar Code
B84025E	Acero Inoxidable Stainless Steel	0,6 mm	8421196125872
B84025D	Lacado Blanco White Lacquered	1,0 mm	8421196125889

#### Perfil 20 x 20 mm / Section 20 x 20 mm

Ref.	Acabado Finish	Espesor Thickness	Código Barras Bar Code
B804056	Acero Inoxidable Stainless Steel	0,6 mm	8421196101050
B804456	Lacado Blanco White Lacquered	1,0 mm	8421196109124
B806756	Aluminio Aluminium	1,0 mm	8421196105652
B807756	Madera Clara Clear Wood	0,6 mm	8421196112803
B808756	Madera Oscura Dark Wood	0,6 mm	8421196112810
B809756	Madera Pino Pine Wood	0,6 mm	8421196117105

#### Perfil 25 x 25 mm / Section 25 x 25 mm

Ref.	Acabado Finish	Espesor Thickness	Código Barras Bar Code
B804256	Acero Inoxidable Stainless Steel	0,6 mm	8421196113244
B804556	Lacado Blanco White Lacquered	1,0 mm	8421196111448
B806856	Aluminio Aluminium	1,0 mm	8421196113275
B807856	Madera Clara Clear Wood	0,6 mm	8421196113305
B808856	Madera Oscura Dark Wood	0,6 mm	8421196113336
B809856	Madera Pino Pine Wood	0,6 mm	8421196117112

#### Perfil 30 x 30 mm / Section 30 x 30 mm

Ref.	Acabado Finish	Espesor Thickness	Código Barras Bar Code
B804656	Lacado Blanco White Lacquered	1,5 mm	8421196116672
B805556	Acero Inoxidable Stainless Steel	0,6 mm	8421196117068



### Ángulos PVC con Adhesivo

Ángulos de plástico PVC con adhesivo para protección de esquinas.

Longitud: 2,5 m

Perfil: 25 x 25 mm

Espesor: 1 mm

### Corner Guard PVC Adhesive

PVC plastic angles with adhesive for corner protection.

Length: 2.5 m

Section: 25 x 25 mm

Thickness: 1 mm

Ref.	Acabado Finish	Código Barras Bar Code
B60415B	Blanco White	8421196124462
B60415N	Negro Black	8421196124479
B60415G	Gris satinado Grey satin	8421196124486
B60415H	Madera Haya Beech Wood	842119612523
B60415X	Madera Pino Pine Wood	8421196124493
B60415Y	Madera Roble Oak Wood	8421196124509
B60415Z	Madera Sapeli Sapele Wood	8421196124516







### Ángulos MDF sin Adhesivo

Ángulos de aglomerado tipo DM para protección de esquinas.  
Longitud: 2,43 m  
Perfil: 30 x 30 mm.  
Espesor: 4 mm

### Corner Guard MDF without Adhesive

MDF wood fibreboard angles for corner protection.  
Length: 2.43 m  
Section: 30 x 30 mm.  
Thickness: 4 mm

Ref.	Acabado Finish	Código Barras Bar Code
B60455B	Blanco White	8421196125049
B60455A	Aluminio Aluminium	8421196125032
B60455H	Madera Haya Beech Wood	8421196125056
B60455X	Madera Pino Pine Wood	8421196125063
B60455Y	Madera Roble Oak Wood	8421196125070
B60455Z	Madera Sapeli Sapele Wood	8421196125087



### Ángulos MDF con Adhesivo

Ángulos de aglomerado tipo DM con adhesivo para protección de esquinas.  
Longitud: 2,43 m  
Perfil: 30 x 30 mm. Espesor: 4 mm



### Corner Guard MDF with Adhesive

MDF wood fibreboard angles with adhesive for corner protection.  
Length: 2.43 m  
Section: 30 x 30 mm. Thickness: 4 mm

Ref.	Acabado Finish	Código Barras Bar Code
B60465B	Blanco White	8421196125100
B60465A	Aluminio Aluminium	8421196125094
B60465H	Madera Haya Beech Wood	8421196125117
B60465X	Madera Pino Pine Wood	8421196125124
B60465Y	Madera Roble Oak Wood	8421196125131
B60465Z	Madera Sapeli Sapele Wood	8421196125148







### Cubre Esquinas y Rincones

Lámina de PVC decorado que se adapta para su utilización como ángulo cubre esquinas o rincones. Incluye adhesivo de alta calidad en sus dos caras para su colocación.

Perfil: 20 x 20 mm  
Longitud: 2,5 m

### Corner Guard

Corner guard made with a PVC decorated band. Suitable for internal and external corners. High quality adhesive in the two internal surfaces for a perfect fixing.

Section: 20 x 20 mm  
Length: 2.5 m



Ref.	Acabado Finish	Código Barras Bar Code
B60260B	Blanco White	8421196102866
B60260Y	Madera Clara Clear Wood	8421196102941
B60260Z	Madera Oscura Dark Wood	8421196106093

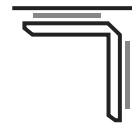
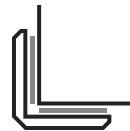

# Adhesivos y Selladores

## Adhesives and Sealants

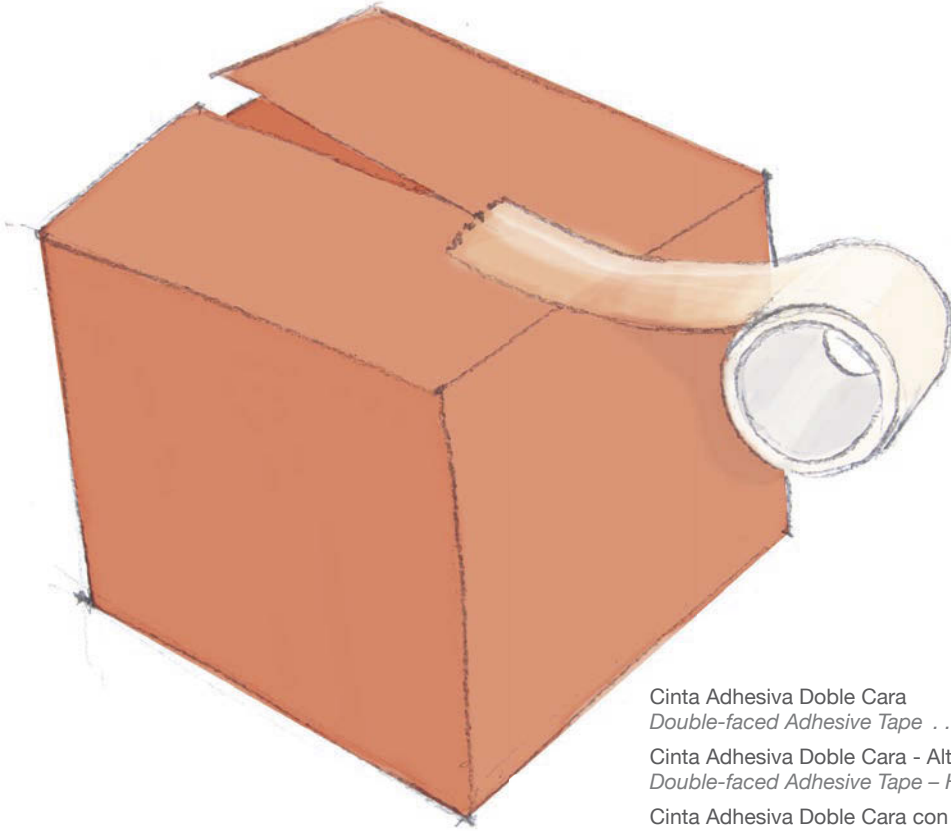

Cinta Adhesiva Doble Cara <i>Double-faced Adhesive Tape</i> .....	118
Cinta Adhesiva Doble Cara - Alta Resistencia <i>Double-faced Adhesive Tape - High Resistance</i> .....	119
Cinta Adhesiva Doble Cara con Malla <i>Double-faced Adhesive Tape with Mesh</i> .....	119
Cinta Adhesiva Doble Cara para Moqueta <i>Double-faced Adhesive Tape for Carpet</i> .....	120
Cinta Adhesiva de Aluminio <i>Aluminium Adhesive Tape</i> .....	120
Cinta Adhesiva Especial Azulejos y Baños <i>Adhesive Tape for Tiles and Bathrooms</i> .....	121
Cinta Adhesiva Extrafina <i>Extra-thin Adhesive Tape</i> .....	121
Cinta Multiusos <i>Multi-use Adhesive Tape</i> .....	122
Cinta de Señalización Adhesiva <i>Adhesive Marking Tape</i> .....	122
Cinta Americana <i>Multi-use Cloth Duct Tape</i> .....	123
Sellador Adhesivo Impermeable <i>Waterproof Adhesive Joint</i> .....	124
Cinta Adhesiva de Sellado Impermeable <i>Waterproof Adhesive Sealing Tape</i> .....	124
Cinta Adhesiva Reparación Mosquitera <i>Adhesive Tape for Mosquito Net Repair</i> .....	124
Adhesivo Removible <i>Removable Adhesive</i> .....	125
Adhesivo Removible de Silicona <i>Removable Silicone Adhesive</i> .....	125
Glu-Xtreme. Adhesivo de montaje extra fuerte <i>Glu-Xtreme. Extra strong mounting glue</i> .....	126
Cinta Autovulcanizable <i>Self Bonding Tape</i> .....	126



### Cinta Adhesiva Doble Cara

Cinta adhesiva doble cara para usos genéricos.  
Alta adherencia en una cinta adhesiva de máxima calidad.  
Adhesivo: Acrílico.  
Base: Espuma de polietileno de 0,8 mm de espesor.  
Adhesión al Acero: 11 N/25 mm  
Resistencia temperatura: -10 N ~ + 90°C  
Papel siliconado color blanco.

### Double-faced Adhesive Tape

Double-face adhesive tape with high adhesion.  
Adhesive: Acrylic.  
Base: 0.8 mm thickness polyethylene foam.  
Adhesion to Stainless Steel: 11 N/ 25 mm  
Service Temperature: -10 N ~ + 90 °C  
White silicone paper.

#### Ancho 12 mm / Width 12 mm

Ref.	Longitud Length		Código Barras Bar Code
B62000B	2,5 m	10	8421196105874
B62010B	5 m	10	8421196105881
B70300B	80 cm	20	8421196101517
B70310B	1,5 m	20	8421196101524



#### Ancho 19 mm / Width 19 mm

Ref.	Longitud Length		Código Barras Bar Code
B62020B	2,5 m	10	8421196105898
B62030B	5 m	10	8421196105904
B70320B	80 cm	20	8421196101531
B70330B	1,5 m	20	8421196101548



#### Ancho 25 mm / Width 25 mm

Ref.	Longitud Length		Código Barras Bar Code
B62040B	2,5 m	10	8421196105911
B62050B	5 m	10	8421196105928



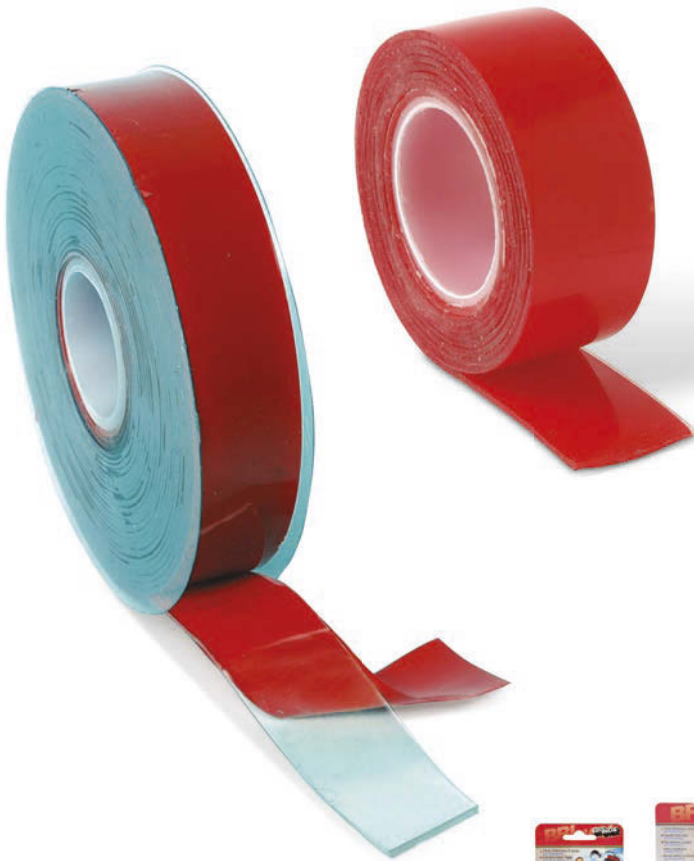

**Cinta Adhesiva Doble Cara. Alta Resistencia**

Cinta de adhesivo 100% acrílico puro sin base. Alta adhesividad con prestaciones excelentes a medio plazo. Posee un tack (adhesividad inicial) bajo, por lo que es fácilmente reposicionable. Homologada por SEAT y NISSAN para la sujeción de piezas en el exterior del automóvil. Buena resistencia a los UV y a la intemperie. Gracias a su gran transparencia es muy utilizado para el adhesivado de cristales y espejos. Cinta fácilmente moldeable.

Adhesivo: Acrílico  
Color: Transparente.  
Espesor: 1 mm  
Adhesión al Acero: 33 N/10 mm  
Temperatura de aplicación: 20 ~ 40 °C  
Resistencia a la Temperatura (1h/°C): -40 ~ +170 °C

**Double-faced Adhesive Tape – High Resistance**

100 % pure acrylic tape without base. High resistance with excellent medium-term results. It has a low initial adhesivity that allows it to be easily repositionable.

Approved by SEAT and NISSAN for the outdoor automobile component fixing.

Good resistance to UV and bad weather.

Because of its transparency it is specially used with glass and mirrors.

Adhesive: Acrylic  
Colour: Transparent

Thickness: 1 mm

Adhesion to Stainless Steel: 33 N/ 10 mm

Application temperature : 20 ~ 40 °C

Temperature resistance (1h / °C) : -40 ~ +170 °C

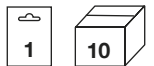

Ref.	Ancho Width	Longitud Length	Código Barras Bar Code
B62100H	19 mm	1,5 m	8421196116252
B62110H		5 m	8421196116696

**Cinta Adhesiva Doble Cara con Malla**

Cinta adhesiva doble cara con un adhesivo de caucho especial, reforzada con malla. Adhesivo especialmente indicado para fijación de paneles en paredes, panelados de composite, paneles en auto caravanas, fijación permanente de moquetas y cortinas, fijación de displays, etc. Todas aquellas fijaciones en las que se requiera una alta resistencia a la cizalla y a la alta temperatura.

Adhesivo: Caucho especial.  
Color: Transparente.  
Espesor: 0,8 mm  
Adhesión al Acero: 45 N/25 mm  
Resistencia a la Temperatura (1h/°C): -10 ~ +70 °C

**Double-faced Adhesive Tape with Mesh**

Double-sided adhesive tape with a special rubber adhesive, reinforced with mesh. Adhesive especially suitable for fixing panels to walls, composite panels, panels in motor homes, permanent fixing of carpets and curtains, fixing of exhibitions, etc. All fixation that requires a high shear and high temperature resistance.

Adhesive: Special rubber

Colour: Transparent

Thickness: 0.8 mm

Adhesion to Stainless Steel: 45 N/25 mm

Application temperature : 20 ~ 400 °C

Temperature resistance (1h / °C) : -40 ~ +170 °C



Ref.	Ancho Width	Longitud Length	Código Barras Bar Code
B62150H	19 mm	2,5 m	8421196124165
B62160H		5 m	8421196124172





### Cinta Adhesiva Doble Cara para Moqueta

Cinta adhesiva especialmente diseñada para adhesivar Moqueta. Su base está formada por una tela delgada de gasa que la convierte en una cinta ideal para utilizar en aplicaciones de moqueta, sin dejar marca de la cinta al otro lado de la moqueta.

Adhesivo: Acrílico. Base: Tèxtil.  
Adhesividad al Acero: 13 N/25 mm  
Ancho: 45 mm. Espesor: 0,25 mm

### Double-faced Adhesive Tape for Carpet

Adhesive tape specially designed for carpet fixing. Its base is composed with a fine fabric of gas that makes it ideal to install a carpet without leaving mark.

Adhesive: Acrylic. Base: Textile mesh.  
Adhesion to Stainless Steel: 13 N/25 mm  
Width: 45 mm. Thickness: 0.25 mm



Ref.	Longitud Length			Código Barras Bar Code
B61070B	5 m	1	10	8421196104501
B61080B	10 m	1	10	8421196104525
B61095B	50 m	x	4	8421196118676



### Cinta Adhesiva de Aluminio

Cinta adhesiva de Aluminio ideal para la colocación de tubos de chimenea, construcción de conductos de aire, acoplamiento de extractores a tubos... Alto nivel de aislante térmico.

Ancho 50 mm. Longitud 5 m. Espesor: 45 micras  
Soporte: Aluminio. Adhesivo: Acrílico modificado  
Fuerza adhesiva: 16 N / 25 mm. Temperatura de aplicación -20°C ~ +100°C

### Aluminium Adhesive Tape

Aluminium adhesive tape ideal for the chimney pipe fixing, the construction of ventilation shafts, the connexion from a kitchen hood to a pipe. High level of thermic insulation.

Width: 50 mm. Length: 5 m. Thickness: 45 microns  
Support: Aluminium. Adhesive: Modified acrylic  
Adhesive power: 16 N / 25 mm. Application temperature: -20°C ~ + 100°C



Ref.	Acabado Finish	Código Barras Bar Code
B61400A	Aluminio Aluminium	8421196114869
B61400B	Blanco White	8421196123182



### Cinta Adhesiva Especial Azulejos y Baños

Cinta adhesiva especialmente diseñada para azulejos. Su base está formada por una espuma de polietileno que la convierte en una cinta ideal para utilizar en aplicaciones de fijación de espejos, cristales, perfiles...

Adhesivo: Acrílico solvente. Base: Espuma de Polietileno.

Adhesividad al Acero: 18 N/25 mm

Ancho: 19 mm. Espesor: 1 mm

### Adhesive Tape for Tiles and Bathrooms

Adhesive tape specially designed for tiles. Its base is composed by a polyethylene foam that makes it an ideal tape for fixing mirrors, glass, profiles...

Adhesive: Acrylic. Base: Polyethylene Foam.

Adhesion to Stainless Steel: 18 N/25 mm

Width: 19 mm. Thickness: 1 mm

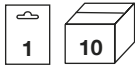

Ref.	Dimensiones Size	Código Barras Bar Code
B62200B	19 mm x 1,5 m	8421196125704



### Cinta Adhesiva Extrafina

Cinta adhesiva extrafina de alta adhesión con soporte de PVC. Su espesor es de tan solo 0,25 mm, lo que la convierte en una cinta ideal para manualidades y trabajos que requieren un acabado liso, listones y perfiles.

Adhesivo: Acrílico. Base: PVC.

Adhesividad al Acero: >40 N/25 mm

Ancho: 18 mm. Espesor: 0,25 mm

### Extra-thin Adhesive Tape

Extra-thin high adhesion adhesive tape with PVC backing. Its thickness is only 0.25 mm, which makes it an ideal tape for crafts and jobs that require a smooth finish, strips and profiles.

Adhesive: Acrylic. Base: PVC.

Adhesion to Stainless Steel: >40 N/25 mm

Width: 18 mm. Thickness: 0.25 mm



Ref.	Dimensiones Size	Código Barras Bar Code
B62220B	18 mm x 5 m	8421196125711



**Cinta Multiusos**

Cinta adhesiva de tela multiusos  
Base: Polietileno laminado impermeable sobre filamento de tela.  
Adhesivo: Acrílico.  
Tensión de Rotura: 35 N/10 mm  
Adhesión al Acero: 4 N/10 mm  
Espesor: 0,17 mm  
Temperatura de Servicio: 0 ~ 60 °C  
Ancho 50 mm. Longitud 10 m

**Multi-use Adhesive Tape**

Multi-use adhesive cloth tape  
Base: Waterproof laminate polyethylene over a fabric mesh  
Adhesive: Acrylic.  
Tensile Strength: 35 N/10 mm  
Adhesion to Stainless Steel: 4 N/10 mm  
Thickness: 0.17 mm  
Service Temperature: 0 ~ 60 °C  
Width 50 mm. Length 10 m



Ref.	Acabado Finish	Código Barras Bar Code
B61140B	Blanco White	8421196115712
B61140N	Negro Black	8421196115729
B61140P	Plata Silver	8421196115736

**Cinta de Señalización Adhesiva**

Cinta adhesiva para el marcaje de suelos y señalización de superficies.  
Base: Lámina de PVC.  
Tensión de Rotura: 4,0 kg/25 mm  
Adhesión al Acero: 0,34 kg/25 mm  
Espesor: 0,17 mm  
Ancho 50 mm. Longitud 30 m

**Adhesive Marking Tape**

Adhesive tape for floor marking and signaling.  
Base: PVC foil.  
Tensile Strength: 4.0 kg/25 mm  
Adhesion to Stainless Steel: 0.34 kg/25 mm  
Thickness: 0.17 mm  
Width 50 mm. Length 30 m



Ref.	Color Colour	Código Barras Bar Code
B61705A	Amarillo Yellow	8421196125230
B61705N	Negro/Amarillo Black/Yellow	8421196125247
B61705R	Rojo/Blanco Red/White	8421196125254





**Cinta Americana**

Cinta adhesiva de gran resistencia a la rotura por estiramiento, diseñada para múltiples propósitos.

Importada directamente desde Estados Unidos en colaboración con uno de los fabricantes de cintas más prestigiosos.

Base: Lámina impermeable de polietileno sobre base de venda de poliéster y algodón

Adhesivo: Goma Natural

Tensión de Rotura: 47.3 N/10 mm

Adhesión al Acero: 5.47 N/10 mm

Espesor: 0.25 mm

Elongación: 15 %

Temperatura de Servicio: 10 ~ 93 °C

**Cloth Duct Tape**

Adhesive cloth duct tape for general purpose: packaging, bundling, sealing, seaming, repairing, holding and waterproofing.

Imported directly from the USA in collaboration with one of the most prestigious manufacturers.

Base: polyethylene waterproofing layer on a polyester and cotton stripe

Adhesive: Natural rubber

Tensile Strength: 47.3 N/10 mm

Adhesion to Stainless Steel: 5.47 N/10 mm

Thickness: 0.25 mm

Elongation: 15%

Service Temperature: 10 ~ 93 °C



Ancho 25 mm. Longitud 10 m / Width 25 mm. Length 10 m

Ref.	Acabado Finish	Código Barras Bar Code
B61100B	Blanco White	8421196107809
B61100N	Negro Black	8421196107816
B61100P	Plata Silver	8421196107793



Ancho 50 mm. Longitud 10 m / Width 50 mm. Length 10 m

Ref.	Acabado Finish	Código Barras Bar Code
B61110B	Blanco White	8421196107755
B61110N	Negro Black	8421196107762
B61110P	Plata Silver	8421196106697
B61110A	Fluorescente Amarillo Fluorescent Yellow	8421196116207
B61110T	Fluorescente Naranja Fluorescent Orange	8421196116191

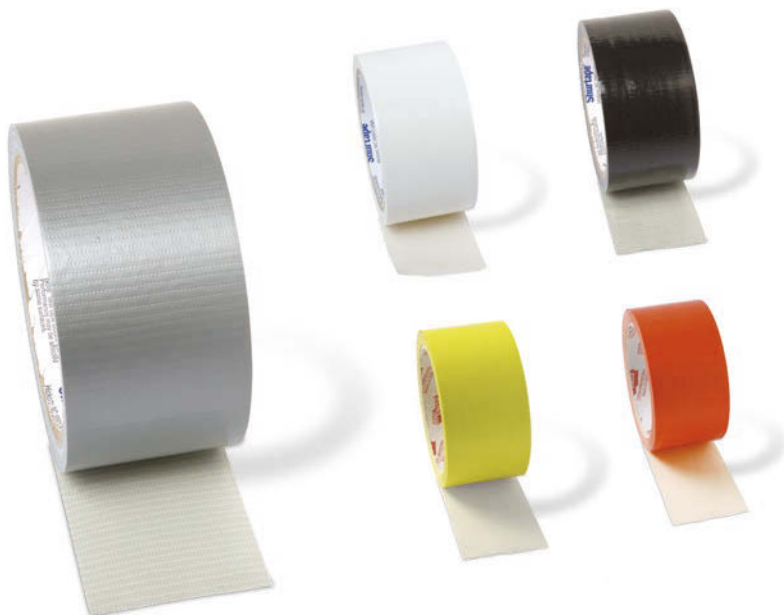

Ancho 48 mm. Longitud 55 m / Width 48 mm. Length 55 m

Ref.	Acabado Finish	Código Barras Bar Code
B61125P	Plata Silver	8421196111196



Calidad / Quality  
**Shurtape®**





**Sellador Adhesivo Impermeable**

Junta cubre rincones impermeable. Ideal para baños y aseos.  
Adhesivo impermeable e hipoalergénico.  
Adhesivo: Goma de Butilo.  
Base: Tira a base de mezcla de PVC y polietilenos.

**Waterproof Adhesive Joint**

Waterproof and hypo-allergenic adhesive joint.  
Ideal for WC and bathrooms.  
Adhesive: Butyl rubber.  
Base: Band made with a mixture of PVC and polyethylene.



Ref.	Dimensiones Size	Código Barras Bar Code
B60200B	22 mm x 2,4 m	8421196116689

**Cinta Adhesiva de Sellado Impermeable**

Cinta adhesiva transparente para sellar fugas de agua, tanques, tuberías, náuticas, reparaciones de lonas, toldos y carpas, entre otras aplicaciones en contacto con el agua. Puede repararse con el agua fluyendo.  
Adhesivo: Caucho sintético.  
Espesor: 660 ± 50 µ  
Fuerza adhesiva: >55 N/25 mm

**Waterproof Adhesive Sealing Tape**

Transparent adhesive tape for sealing water leaks, tanks, pipes, nautical, tarpaulin repairs, awnings and tents, among other applications in contact with water. It can be repaired with flowing water.  
Adhesive: Synthetic rubber.  
Thickness: 660 ± 50 µ  
Adhesive strenght: >55 N/25 mm



Ref.	Dimensiones Size	Código Barras Bar Code
B62255H	100 mm x 1,5 m	8421196125728

**Cinta Adhesiva Reparación Mosquitera**

Cinta adhesiva para reparar mosquiteras. Fabricada con tela de fibra de vidrio con una construcción de malla, caracterizada por tener buena transmisión y por ser transpirable.  
Color: Gris

**Adhesive Tape for Mosquito Net Repair**

Adhesive tape for mosquito net repair. Made of fiberglass fabric with a mesh construction, characterized by its good transmission and breathability.  
Colour: Grey



Ref.	Dimensiones Size	Código Barras Bar Code
B61435G	50 mm x 2 m	8421196125902



**Adhesivo Removible**

Pasta de adhesivo removible color azul claro.  
Útil para colgar papeles, pósters, calendarios... en la pared.  
No deja rastros de adhesivo. Fácilmente moldeable.  
Base: caucho sintético.  
Almacenar en lugar seco a temperatura entre 5° y 25°C.  
Presentación: Display con una placa de 55 g.

**Removable Adhesive**

Light blue convenience paster. It is used to stick papers, posters, calendars... on the wall. It does not leave tracks. It can be removed easily.  
Base: Synthetic rubber.  
Store in a dry place at a temperature between 5° and 25°C.  
Presentation: Packaging with a 55 g sheet.

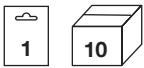

Ref.	Dimensiones Size	Código Barras Bar Code
B61200C	75 x 110 x 4 mm	8421196107854

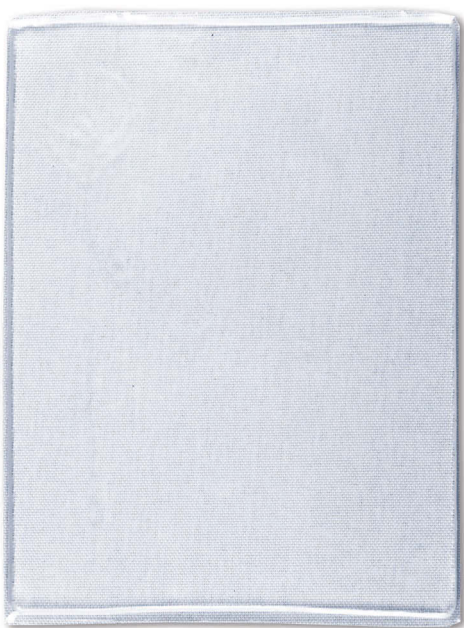

**Adhesivo Removible de Silicona**

Placa de gel de silicona doble cara. Fijación rápida y reutilizable.  
Se puede recortar y lavar para reutilizar. No deja residuos.  
Tamaño: 60 x 80 mm  
Color: Transparente.

**Removable Silicone Adhesive**

Double faced silicone gel plate. Quick and reusable fixing.  
Can be trimmed and washed for reuse. It does not leave residue.  
Size: 60 x 80 mm  
Colour: Transparent.



Ref.	Código Barras Bar Code
B51100H	8421196123120



## GLU-X TREME

Adhesivo de Montaje Extra-Fuerte

### Glu-Xtreme. Adhesivo de montaje extra fuerte

Para pegar materiales porosos con: madera, metal, vidrio, cerámica, PVC, fórmica, corcho, piel, tejidos, papel, cartón... Fija en segundos. Gran poder adhesivo. Sin disolventes. Para uso interior. Presentación en barra de 20 g

### Glu-Xtreme. Extra strong mounting glue

For bonding porous materials with: wood, metal, glass, ceramics, PVC, formica, cork, leather, fabrics, paper, cardboard...

Fixed in seconds. Great adhesive power.

Solvent free. For indoor use. Presentation in bar of 20 g



Ref.	Presentación Packaging			Código Barras Bar Code
B612100	Blister Blister	1	10	8421196121799
B612140	Expositor Exhibitor	x	24	8421196121805

### Cinta Autovulcanizable

Cinta autosoldable para aislamiento de conexiones eléctricas, impermeabilización de empalmes y sujeción de tuberías.

Uso en aplicaciones de interior y exterior.

Resistente al agua

Espesor: 0,5 mm

### Self Bonding Tape

Self sealing tape for insulation of electrical connections, waterproofing of joints and pipe fastening.

Use for indoor and outdoor applications.

Waterproof

Thickness: 0.5 mm



Ref.	Dimensiones Size	Código Barras Bar Code
B61220N	19 mm x 3 m	8421196124189

# Fielros y Deslizadores

## Felt and Sliders

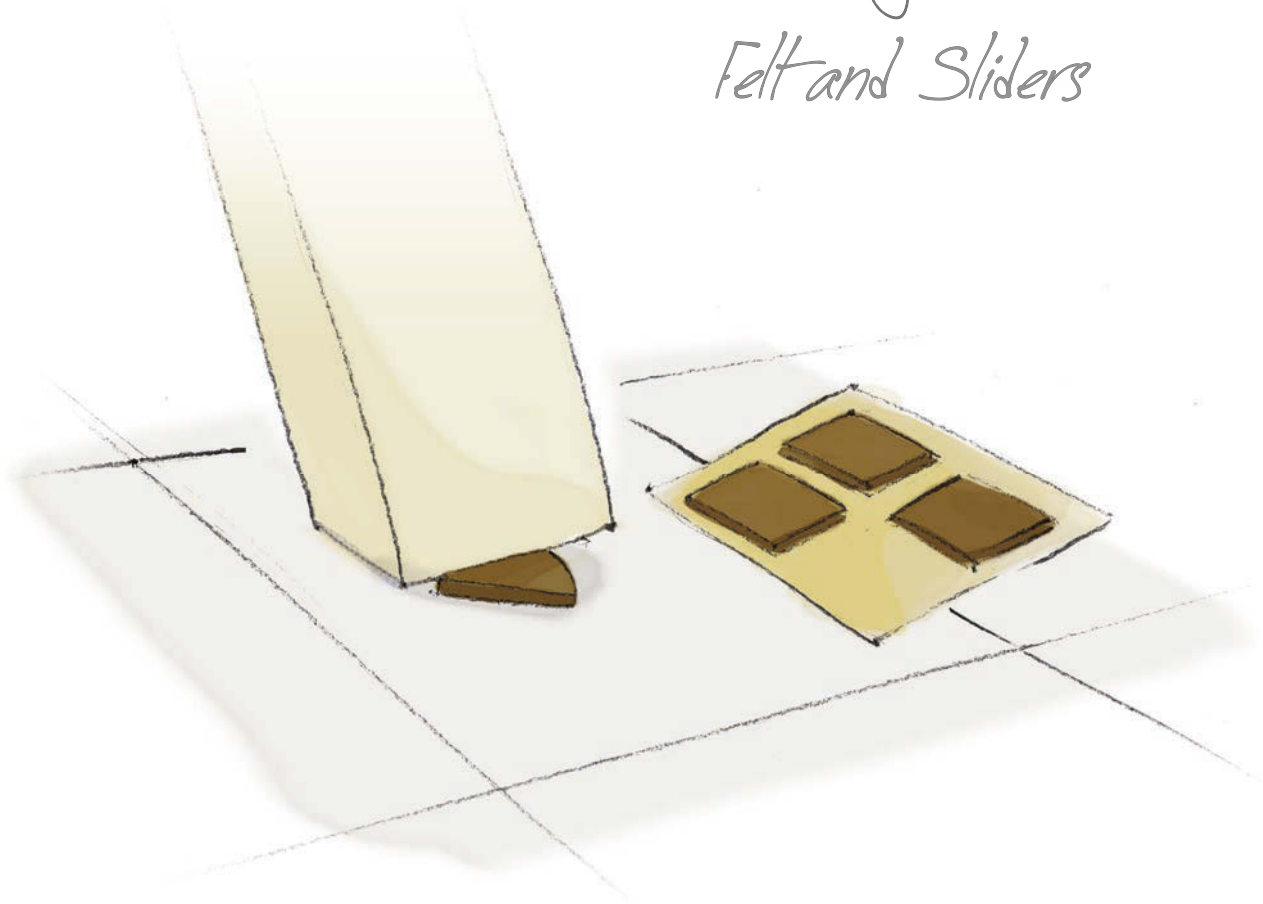

Deslizadores de Fielro <i>Felt Sliders</i> .....	128
Deslizadores de Fielro Sintético <i>Synthetic Felt Sliders</i> .....	132
Patines Deslizadores para Muebles <i>Furniture Sliders</i> .....	134
Deslizadores con Clavo <i>Sliders with Nail</i> .....	136
Conteras Redondas <i>Round Leg Tips</i> .....	137
Conteras Interiores Cuadradas <i>Square Inner Leg Tips</i> .....	138
Conteras Interiores Rectangulares <i>Rectangular Inner Leg Tips</i> .....	138
Conteras Exteriores Redondas de Goma <i>Round Rubber Outer Leg Tips</i> .....	139
Conteras para Andador con Arandela <i>Leg Tips for Walking Aid with Washer</i> .....	139
Conteras con Ventosa para Muletas <i>Leg Tips with Suction Cup for Crutches</i> .....	140
Conteras con Ventosa. Base 80 mm <i>Leg Tips with Suction Cup. 80 mm base</i> .....	140
Conteras con Fuelle <i>Leg Tips with Bellow</i> .....	140





**Deslizadores de Feltro. Redondo**

Deslizadores de fieltro en forma de disco. Protege suelos de cerámica y parquet de las rayadas provocadas por el movimiento de sillas y muebles. Gran diversidad de medidas para todas las necesidades.

Adhesivo: Transfer acrílico de alta adherencia. Espesor: 3 mm

**Felt Sliders. Round**

Round felt protectors. Protect ceramic and wood floors from scratches caused by chair and furniture movements. Wide diversity of sizes.

Adhesive: High adhesion acrylic transfer. Thickness: 3 mm

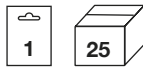

Ref.	Medida Size	Color Colour	Código Barras Bar Code
B70820B	3 discos Ø 42 mm	Blanco White	8421196102422
B70820M		Marrón Brown	8421196102446
B70830B	4 discos Ø 38 mm	Blanco White	8421196102453
B70830M		Marrón Brown	8421196102460
B70800B	5 discos Ø 35 mm	Blanco White	8421196103207
B70800M		Marrón Brown	8421196103214
B70750B	6 discos Ø 30 mm	Blanco White	8421196103108
B70750M		Marrón Brown	8421196103115
B70710B	8 discos Ø 25 mm	Blanco White	8421196103023
B70710M		Marrón Brown	8421196103030
B70730B	12 discos Ø 20 mm	Blanco White	8421196103061
B70730M		Marrón Brown	8421196103078
B70770B	20 discos Ø 16 mm	Blanco White	8421196103146
B70770M		Marrón Brown	8421196103153





**Deslizadores de Feltro. Cuadrado**

Deslizadores de fieltro en forma rectangular. Protege suelos de cerámica y parquet de las rayadas provocadas por el movimiento de sillas y muebles. Gran diversidad de medidas para todas las necesidades.

Adhesivo: Transfer acrílico de alta adherencia. Espesor: 3 mm

**Felt Sliders. Square**

Square and band felt protectors. Protects ceramic and parquet floors from scratches caused by chair and furniture movements. Wide diversity of size.

Adhesive: High adhesion acrylic transfer. Thickness: 3 mm

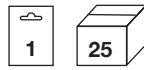

Ref.	Medida Size	Color Colour	Código Barras Bar Code
B70700B	1 rectángulo 1 rectangle	Blanco White	8421196103009
B70700M	100 x 85 mm	Marrón Brown	8421196103016
B70840B	4 rectángulos 4 rectangles	Blanco White	8421196102477
B70840M	44 x 38 mm	Marrón Brown	8421196102484
B70810B	5 rectángulos 5 rectangles	Blanco White	8421196111288
B70810M	28 x 44 mm	Marrón Brown	8421196111295
B70740B	12 rectángulos 12 rectangles	Blanco White	8421196103085
B70740M	20 x 23 mm	Marrón Brown	8421196103092
B70720B	16 rectángulos 16 rectangles	Blanco White	8421196103047
B70720M	16 x 20 mm	Marrón Brown	8421196103054
B70760B	5 tiras 5 bands	Blanco White	8421196103122
B70760M	13 x 91 mm	Marrón Brown	8421196103139





**Deslizadores de Feltro. Surtido**

Surtido de 69 feltros deslizadores compuesto de:  
1 placa de 100 x 270, 20 discos Ø 16 mm,  
12 discos Ø 20 mm, 8 discos Ø 25 mm,  
16 rectángulos 16 x 20 mm  
y 12 rectángulos 20 x 23 mm  
Adhesivo: Transfer acrílico de alta adherencia.  
Espesor: 2,5 ~ 3 mm

**Felt Sliders. Assortment**

Assortment of 69 Felt sliders with:  
1 sheet of 100 x 270, 20 discs Ø 16 mm,  
12 discs Ø 20 mm, 8 discs Ø 25 mm,  
16 squares 16 x 20 mm y 12 squares 20 x 23 mm  
Adhesive: High adhesion acrylic transfer.  
Thickness: 2.5 ~ 3 mm

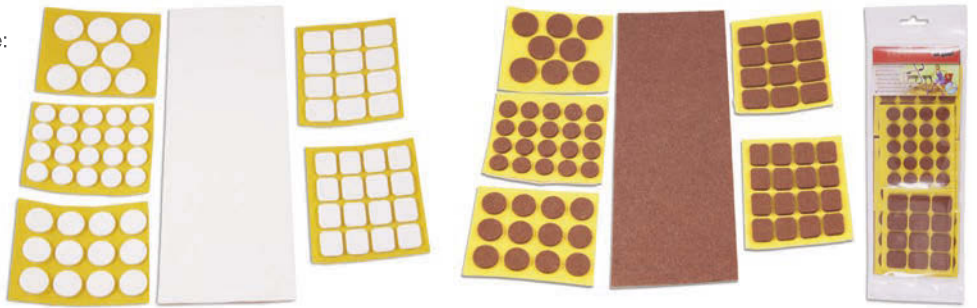

Ref.	Color Colour	Código Barras Bar Code
B62810B	Blanco / White	8421196122536
B62810M	Marrón / Brown	8421196122543

**Deslizadores de Feltro. Rollo**

Deslizadores de feltro en rollos.  
Protege suelos de cerámica y parquet de las rayadas provocadas por el movimiento de sillas y muebles. Gran diversidad de medidas para todas las necesidades.  
Adhesivo: Transfer acrílico de alta adherencia.  
Espesor: 2,5 ~ 3 mm

**Felt Sliders. Roll**

Felt sliders in rolls.  
Protects ceramic and parquet floors from scratches caused by chair and furniture movements. Wide diversity of size. for all needs.  
Adhesive: High adhesion acrylic transfer.  
Thickness: 2.5 ~ 3 mm

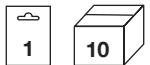
**Ancho 19 mm / Width 19 mm**

Ref.	Longitud Length	Color Colour	Código Barras Bar Code
B62720B	100 cm	Blanco White	8421196108462
B62720M		Marrón Brown	8421196108455
B62730B	200 cm	Blanco White	8421196108486
B62730M		Marrón Brown	8421196108479

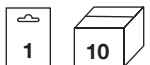
**Ancho 25 mm / Width 25 mm**

Ref.	Longitud Length	Color Colour	Código Barras Bar Code
B62740B	100 cm	Blanco White	8421196108509
B62740M		Marrón Brown	8421196108493
B62750B	200 cm	Blanco White	8421196108516
B62750M		Marrón Brown	8421196108523

**Ancho 85 mm / Width 85 mm**

Ref.	Longitud Length	Color Colour	Código Barras Bar Code
B62760B	100 cm	Blanco White	8421196110991
B62760M		Marrón Brown	8421196111004



Ancho 85 mm / Width 85 mm



Ref.	Longitud Length	Color Colour	Código Barras Bar Code
B62795M	25 m	Marrón Brown	8421196115057

Ancho 200 mm / Width 200 mm

Ref.	Longitud Length	Color Colour		Código Barras Bar Code
B62775M	50 cm	Marrón Brown	10	8421196111752
B62785M	100 cm	Marrón Brown	6	8421196111776



Ancho 45 cm / Width 45 cm



Ref.	Longitud Length	Color Colour	Código Barras Bar Code
B70905B	170 cm	Blanco White	8421196105959
B70905M		Marrón Brown	8421196105744





**Deslizadores de Feltro Sintético. Redondo**

Deslizadores de fieltro en forma de disco. Protege suelos de cerámica y parquet de las rayadas provocadas por el movimiento de sillas y muebles. Gran diversidad de medidas para todas las necesidades.

Adhesivo: Hot-melt.  
Espesor: 2,5 ~ 3 mm

**Synthetic Felt Sliders. Round**

Round felt sliders. Protects ceramic floors and parquet from the scratches caused by the movement of chairs and furniture.

Great diversity of measures for all needs.

Adhesive: Hot-melt  
Thickness: 2.5 ~ 3 mm

Ref.	Medida Size	Color Colour	Código Barras Bar Code
B76080G	3 discos Ø 42 mm	Gris Grey	8421196124004
B76080M		Marrón Brown	8421196124011
B76070G	4 discos Ø 38 mm	Gris Grey	8421196123984
B76070M		Marrón Brown	8421196123991
B76060G	5 discos Ø 35 mm	Gris Grey	8421196123960
B76060M		Marrón Brown	8421196123977
B76050G	6 discos Ø 30 mm	Gris Grey	8421196123946
B76050M		Marrón Brown	8421196123953
B76040G	8 discos Ø 25 mm	Gris Grey	8421196123922
B76040M		Marrón Brown	8421196123939
B76030G	12 discos Ø 20 mm	Gris Grey	8421196123908
B76030M		Marrón Brown	8421196123915
B76020G	20 discos Ø 16 mm	Gris Grey	8421196123885
B76020M		Marrón Brown	8421196123892

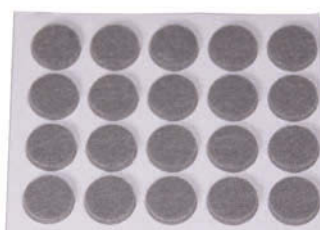
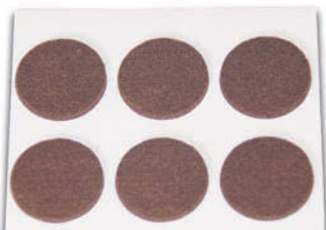
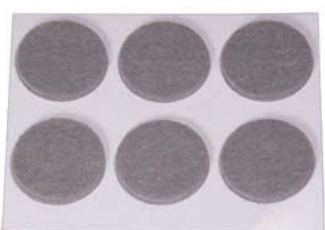
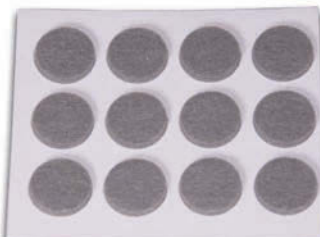
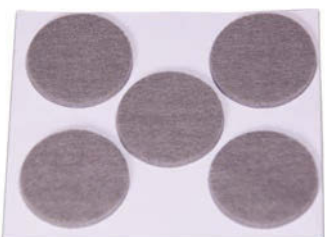
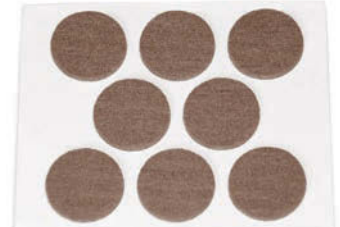
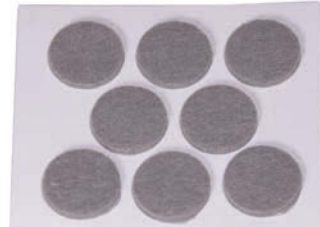
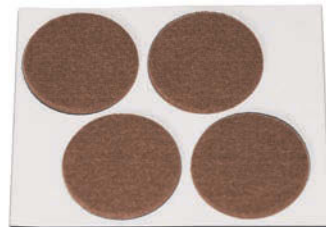
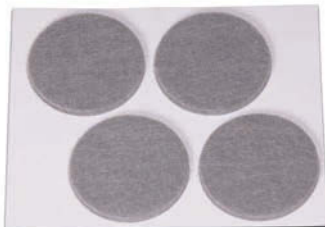
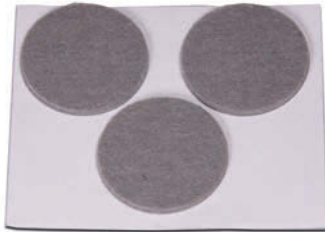

**Deslizadores de Feltro Sintético. Cuadrado y Rollo**

Deslizadores de fieltro. Protege suelos de cerámica y parquet de las rayadas provocadas por el movimiento de sillas y muebles. Gran diversidad de medidas para todas las necesidades. Adhesivo: Hol-melt. Espesor: 2,5 ~ 3 mm

**Synthetic Felt Sliders. Square and Roll**

Felt sliders. Protects ceramic and parquet floors from scratches caused by the movement of chairs and furniture. Great diversity of measures for all needs. Adhesive: Hot-melt Thickness: 2.5 ~ 3 mm

Ref.	Medida Size	Color Colour	Código Barras Bar Code
B76160G	1 rectángulo 1 rectangle	Gris Grey	8421196124127
B76160M	100 x 85 mm	Marrón Brown	8421196124134
B76150G	5 tiras 5 bands	Gris Grey	8421196124103
B76150M	13 x 91 mm	Marrón Brown	8421196124110
B76140G	4 rectángulos 4 rectangles	Gris Grey	8421196124080
B76140M	44 x 38 mm	Marrón Brown	8421196124097
B76130G	5 rectángulos 5 rectangles	Gris Grey	8421196124066
B76130M	28 x 44 mm	Marrón Brown	8421196124073
B76120G	12 rectángulos 12 rectangles	Gris Grey	8421196124042
B76120M	20 x 23 mm	Marrón Brown	8421196124059
B76110G	16 rectángulos 16 rectangles	Gris Grey	8421196124028
B76110M	16 x 20 mm	Marrón Brown	8421196124035
B76210G	1 rollo 1 tape	Gris Grey	8421196124141
B76210M	85 mm x 100 cm	Marrón Brown	8421196124158

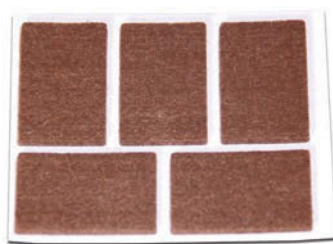
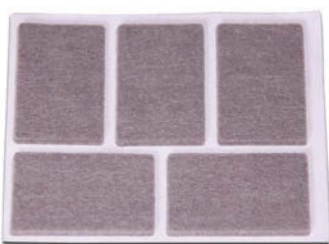
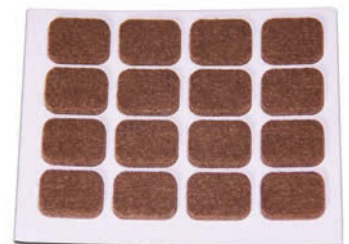
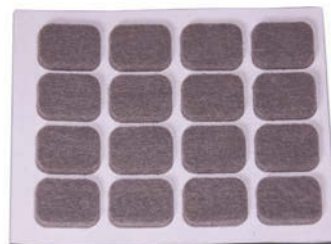
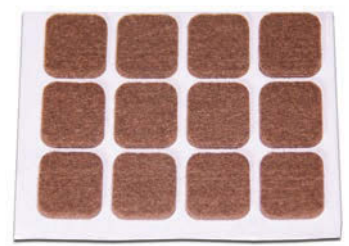
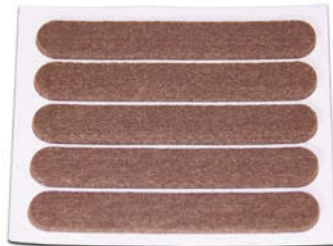
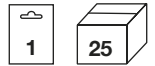



### Patines Deslizadores para Muebles. Adhesivo y Tornillo

Deslizadores para muebles fabricados en plástico.  
Gran diversidad de formas para todas las necesidades.  
Adhesivo de alta calidad. Incluye tornillos para una mejor fijación  
Color: Gris

### Furniture Sliders. Adhesive and Screw

Sliders for furnitures made of plastic.  
Wide range of Patterns for all needs.  
High quality adhesive. Include screws for a better fixing.  
Colour: Grey



10

### Redondos / Round

Ref.	Medida Size		Código Barras Bar Code
B77500G	Ø 63 mm	2	8421196119383
B77510G	Ø 50 mm	4	8421196119376
B77520G	Ø 38 mm	4	8421196119369
B77530G	Ø 25 mm	8	8421196119352
B77540G	Ø 22 mm	8	8421196119345



10

### Cuadrados / Square

Ref.	Medida Size		Código Barras Bar Code
B77600G	54 x 54 mm	2	8421196119338
B77610G	35 x 35 mm	4	8421196119321
B77620G	24 x 24 mm	8	8421196119314



### Patines Deslizadores para Muebles. Con Clavo

Deslizadores para muebles fabricados en plástico.  
Gran diversidad de formas para todas las necesidades.  
Color: Gris

### Furniture Sliders. With Nail

Sliders for furnitures made of plastic.  
Wide range of Patterns for all needs.  
Colour: Grey

Ref.	Medida Size		Código Barras Bar Code
B77700G	Ø 32 mm	4	8421196119307
B77710G	Ø 22 mm	6	8421196119291

10





**Patines Deslizadores para Muebles. Adhesivo**

Deslizadores para muebles fabricados en plástico.  
Adhesivo de alta calidad.  
Color: Gris

**Furniture Sliders. Adhesive**

Sliders for furnitures made of plastic.  
High quality adhesive.  
Colour: Grey

Ref.	Medida Size		Código Barras Bar Code
B77750G	15 x 75 mm	4	8421196119284

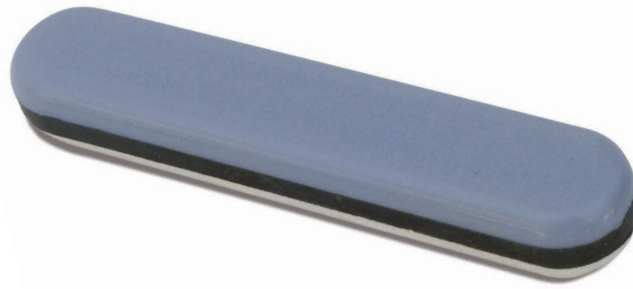

**Patines Deslizadores para Muebles. Adhesivo**

Patín formado de plástico ABS de alta dureza y espuma amortiguadora adhesivada de poliuretano. Ideado para su colocación bajo muebles, sillas, mesas y sofás para proporcionar un fácil deslizamiento.

La espuma amortiguadora facilita la regulación de la altura y evita el aplastamiento del plástico manteniendo así su perfecta funcionalidad.

**Furniture Sliders. Adhesive**

Slider made in long life ABS plastic and adhesive shock absorber polyurethane foam. To be fixed in furniture, chair, table and sofa feet to balance the slide.

The foam shock absorber facilitates the height regulation and avoids crushing the plastic.

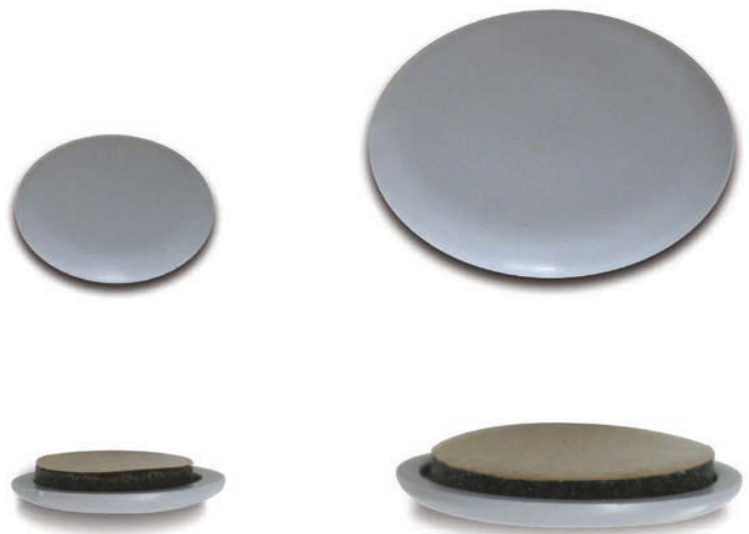

Ref.	Medida Size		Código Barras Bar Code
B77800G	Ø 25 mm	8	8421196118096
B77810G	Ø 40 mm	4	8421196118102



**Deslizadores de Feltro con Clavo**

Deslizadores de fieltro con clavo para muebles. Ideales para patas de mesas y sillas en contacto con parquet y cerámica.  
Color: Marrón

**Felt Sliders with Nail**

Felt sliders with nail for furniture. Ideal for table legs and chairs in contact with parquet and ceramics.  
Colour: Brown



Ref.	Medida Size		Código Barras Bar Code
B77310M	Ø 17 mm	8	8421196119871
B77320M	Ø 20 mm	8	8421196119888
B77330M	Ø 24 mm	8	8421196119895
B77340M	Ø 28 mm	4	8421196119901
B77350M	Ø 35 mm	4	8421196119918

**Deslizadores Metálicos con Clavo**

Deslizadores de cabeza metálica con clavo para muebles. Ideales para patas de mesas y sillas en contacto con alfombras y moqueta.  
Color: Niquelado

**Metallic Furniture Sliders with Nail**

Sliders with metallic head with nail. Ideal for tables and chairs in contact with carpet.  
Colour: Niquel

Ref.	Medida Size	Código Barras Bar Code
B77410N	Ø 27 mm	8421196123403

**Deslizadores de Plástico con Clavo**

Deslizadores para muebles de plástico ABS con clavo. Ideales para patas de mesas y sillas en contacto con cerámica y gres.  
Color: Marrón

**Plastic Sliders with Nail**

Sliders made of ABS plastic with nail. Ideal for tables and chairs in contact with ceramic and stoneware.  
Colour: Brown



Ref.	Medida Size		Código Barras Bar Code
B77820M	Ø 16 mm	8	8421196125742
B77830M	Ø 18 mm	8	8421196125766
B77840M	Ø 20 mm	4	8421196125780
B77860M	Ø 22 mm	4	8421196123373
B77870M	Ø 25 mm	4	8421196123380



### Conteras Exteriores Redondas

Tapones y conteras de PVC para patas de sillas, mesas, bastones...  
Modelo exterior para tubos cilíndricos.  
Color: Negro

#### Round Outer Leg Tips

PVC plugs and ferrules for chair legs, tables, canes...  
External model for cylindrical tubes.  
Colour: Black



Ref.	Medida Size		Código Barras Bar Code
B75220N	Ø 12 mm	8	8421196120853
B75230N	Ø 14 mm	8	8421196120860
B75240N	Ø 16 mm	8	8421196120877
B75250N	Ø 18 mm	8	8421196120884
B75260N	Ø 20 mm	4	8421196120891
B75270N	Ø 22 mm	4	8421196120907
B75280N	Ø 25 mm	4	8421196120914
B75290N	Ø 28 mm	4	8421196120921
B75300N	Ø 30 mm	4	8421196121089
B75310N	Ø 32 mm	4	8421196121096
B75320N	Ø 35 mm	4	8421196121102
B75330N	Ø 40 mm	4	8421196121119



Ref.	Medida Size	Código Barras Bar Code
B75215N	Ø 10 mm	8421196121294
B75225N	Ø 12 mm	8421196121300
B75235N	Ø 14 mm	8421196121317
B75245N	Ø 16 mm	8421196121324
B75255N	Ø 18 mm	8421196121331
B75265N	Ø 20 mm	8421196121348
B75275N	Ø 22 mm	8421196121355
B75285N	Ø 25 mm	8421196121362
B75295N	Ø 28 mm	8421196121379
B75305N	Ø 30 mm	8421196121386
B75315N	Ø 32 mm	8421196121393
B75325N	Ø 35 mm	8421196121409
B75335N	Ø 40 mm	8421196121416
B75345N	Ø 45 mm	8421196121423
B75355N	Ø 50 mm	8421196121430

### Conteras Interiores Redondas

Tapones y conteras de polietileno para patas de sillas, mesas, bastones...  
Modelo interior para tubos cilíndricos.  
Color: Negro

#### Round Inner Leg Tips

Polyethylene plugs and ferrules for chair legs, tables, canes...  
Internal model for cylindrical tubes.  
Colour: Black



Ref.	Medida Size		Código Barras Bar Code
B75430N	Ø 20 mm	4	8421196121126
B75440N	Ø 22 mm	4	8421196121133
B75450N	Ø 25 mm	4	8421196121140
B75460N	Ø 28 mm	4	8421196121157
B75470N	Ø 30 mm	4	8421196121164



Ref.	Medida Size	Código Barras Bar Code
B75415N	Ø 16 mm	8421196121447
B75425N	Ø 18 mm	8421196121454
B75435N	Ø 20 mm	8421196121461
B75445N	Ø 22 mm	8421196121478
B75455N	Ø 25 mm	8421196121485
B75465N	Ø 28 mm	8421196121492
B75475N	Ø 30 mm	8421196121508
B75485N	Ø 32 mm	8421196121515
B75495N	Ø 35 mm	8421196121522
B75505N	Ø 40 mm	8421196121539
B75515N	Ø 45 mm	8421196121546
B75525N	Ø 50 mm	8421196121553

**Conteras Interiores Cuadradas**

Tapones y conteras de polietileno para patas de sillas, mesas, bastones...  
Modelo interior para tubos cuadrados.  
Color: Negro

**Square Inner Leg Tips**

Polyethylene plugs and ferrules for chair legs, tables, canes...  
Internal model for square tubes.  
Colour: Black



Ref.	Medidas Size		Código Barras Bar Code
B75630N	20 x 20 mm	4	8421196121171
B75650N	25 x 25 mm	4	8421196121188
B75660N	30 x 30 mm	4	8421196121195
B75670N	35 x 35 mm	4	8421196121201
B75680N	40 x 40 mm	4	8421196121218



Ref.	Medidas Size	Código Barras Bar Code
B75615N	16 x 16 mm	8421196121560
B75625N	18 x 18 mm	8421196121577
B75635N	20 x 20 mm	8421196121584
B75645N	22 x 22 mm	8421196121591
B75655N	25 x 25 mm	8421196121607
B75665N	30 x 30 mm	8421196121614
B75675N	35 x 35 mm	8421196121621
B75685N	40 x 40 mm	8421196121638
B75695N	45 x 45 mm	8421196121645
B75705N	50 x 50 mm	8421196121652

**Conteras Interiores Rectangulares**

Tapones y conteras de polietileno para patas de sillas, mesas, bastones...  
Modelo interior para tubos rectangulares.  
Color: Negro

**Rectangular Inner Leg Tips**

Polyethylene plugs and ferrules for chair legs, tables, canes...  
Internal model for rectangular tubes.  
Colour: Black



Ref.	Medidas Size	Código Barras Bar Code
B75825N	10 x 25 mm	8421196121676
B75835N	15 x 20 mm	8421196121683
B75845N	15 x 25 mm	8421196121690
B75855N	15 x 30 mm	8421196121706
B75865N	20 x 30 mm	8421196121713
B75875N	20 x 35 mm	8421196121720
B75885N	20 x 40 mm	8421196121737
B75895N	20 x 50 mm	8421196121744
B75905N	30 x 40 mm	8421196121751
B75915N	30 x 50 mm	8421196121768
B75925N	40 x 60 mm	8421196121775
B75935N	40 x 80 mm	8421196121782



**Conteras Exteriores Redondas de Goma**

Tapones y conteras para patas de sillas, mesas, bastones...  
Modelo exterior para tubos cilíndricos.  
Color: Negro

**Round Rubber External Leg Tips**

Plugs and ferrules for chair legs, tables, canes...  
External model for cylindrical tubes.  
Colour: Black



Ref.	Medida Size	Código Barras
B74505N	Ø 10 mm	8421196125421
B74515N	Ø 12 mm	8421196125438
B74525N	Ø 14 mm	8421196125445
B74535N	Ø 16 mm	8421196125452
B74545N	Ø 17 mm	8421196125469
B74555N	Ø 18 mm	8421196125476
B74565N	Ø 20 mm	8421196125483
B74575N	Ø 22 mm	8421196125544
B74585N	Ø 25 mm	8421196125490
B74595N	Ø 28 mm	8421196125506
B74605N	Ø 30 mm	8421196125513
B74615N	Ø 32 mm	8421196125520
B74625N	Ø 35 mm	8421196125537
B74635N	Ø 40 mm	8421196125551

**Conteras para Andador con Arandela**

Tapones y conteras de goma para andadores. La contera cuenta con una arandela para evitar el corte de la base de la contera a raíz del peso del andador.  
Medida: 25 mm

**Leg Tips for Walking Aid with Washer**

Rubber plugs and ferrules for walking aids. The plug is equipped with a washer to avoid cutting the base of the plug due to the weight of the walking aid.  
Size: 25 mm



Ref.	Color Colour	Código Barras Bar Code
B74675N	Negro Black	8421196125575
B74675G	Gris Grey	8421196125568



**Conteras con Ventosa para Muletas**

Tapones y conteras de goma para muletas. La contera cuenta con una ventosa en la base que aporta estabilidad.

**Leg Tips with Suction Cup for Crutches**

Rubber plugs and ferrules for crutches. The plug is equipped with a suction cup at the base that provides stability.



Ref.	Medida Size	Color Colour	Código Barras Bar Code
B74705N	Ø 17 mm	Negro Black	8421196125599
B74705G		Gris Grey	8421196125582
B74715N	Ø 19 mm	Negro Black	8421196125612
B74715G		Gris Grey	8421196125605
B74725N	Ø 21 mm	Negro Black	8421196125636
B74725G		Gris Grey	8421196125629

**Conteras con Ventosa. Base 80 mm**

Tapones y conteras de goma con ventosa. La contera está compuesta por una base de 80 mm que aporta una mayor estabilidad.

**Leg Tips with Suction Cup. 80 mm base**

Rubber plugs and ferrules with suction cup. The plug is composed of an 80 mm base that provides greater stability.



Ref.	Medida Size	Color Colour	Código Barras Bar Code
B74755N	Ø 19 mm	Negro Black	8421196125650
B74755G		Gris Grey	8421196125643
B74765N	Ø 22 mm	Negro Black	8421196125674
B74765G		Gris Grey	8421196125667

**Conteras con Fuelle**

Tapones y conteras de goma, para suelos desnivelados e irregulares, de gran adaptabilidad gracias al fuelle y la amplia base.

Color: Negro

**Leg Tips with Bellow**

Rubber plugs and ferrules for uneven floors with great adaptability thanks to the bellow and the wide base.

Colour: Black

Ref.	Medida Size	Código Barras
B74785N	Ø 19 mm	8421196125681
B74795N	Ø 22 mm	8421196125698



# Antideslizantes

## Non-Slipers

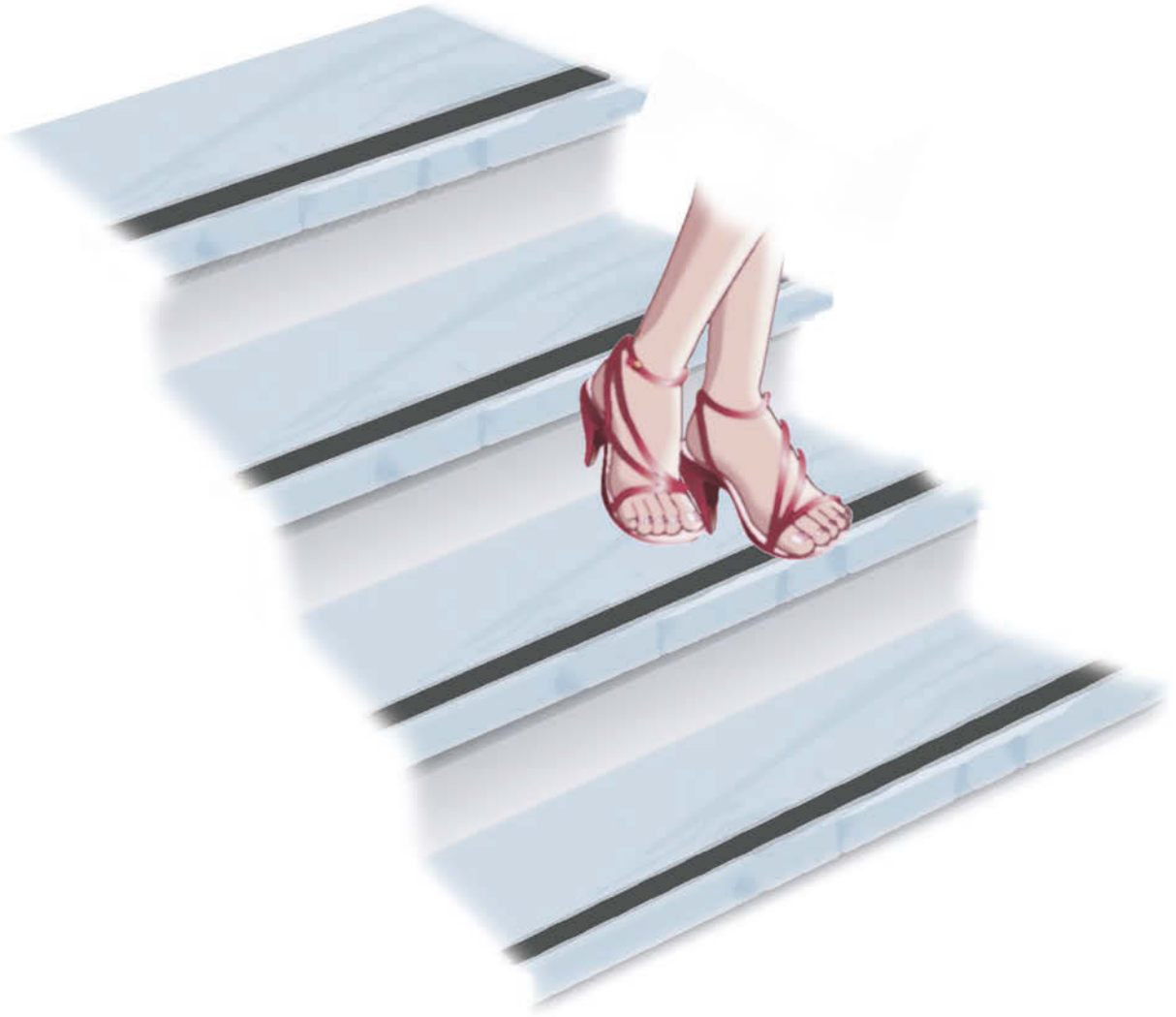

Cinta Antideslizante Adhesiva <i>Non-Slip Adhesive Tape</i> .....	142
Figura Antideslizante Adhesiva para Bañera <i>Adhesive Non-Slip Pattern for Bathtub</i> .....	144
Cinta Antideslizante Adhesiva para Bañera <i>Non-Slip Adhesive Tape for Bathtub</i> .....	144
Antideslizante Granulado Adhesivo. Especial Agua <i>Non-Slip Adhesive Tape. Resistant to water</i> .....	144







### Cinta Antideslizante Adhesiva

Cinta adhesiva en base de caucho con antideslizante.  
Ancho: 25 mm  
Longitud: 5 m

### Non-Slip Adhesive Tape

Adhesive tape with a natural rubber base that contains a non-slip.  
Width: 25 mm  
Length: 5 m



Ref.	Acabado Finish	Código Barras Bar Code
B61300N	Negro Black	8421196112247
B61300B	Blanco White	8421196112230
B61300L	Luminiscente Luminiscent	8421196112827
B61300H	Transparente Transparent	8421196117495
B61300A	Amarillo / Negro Yellow / Black	8421196123731



**Cinta Antideslizante Adhesiva**

Cinta en base de caucho con antideslizante  
Ancho: 40 mm  
Longitud: 5 m

**Non-Slip Adhesive Tape**

Tape made of non-slip rubber  
Width: 40 mm  
Length: 5 m



Ref.	Acabado Finish	Código Barras Bar Code
B61310N	Negro Black	8421196113152
B61310H	Transparente Transparent	8421196117501
B61310A	Amarillo / Negro Yellow / Black	8421196123748

**Cinta Antideslizante Adhesiva**

Cinta en base de caucho con antideslizante.  
Color: Negro  
Longitud: 25 m

**Non-Slip Adhesive Tape**

Tape made of non-slip rubber.  
Colour: Black  
Length: 25 m



Ref.	Ancho Width	Acabado Finish	Icono	Código Barras Bar Code
B61320N	25 mm	Negro Black	6	8421196116931
B61320A		Amarillo / Negro Yellow / Black		8421196124912
B61330N	40 mm	Negro Black	4	8421196118010
B61330A		Amarillo / Negro Yellow / Black		8421196124929



**Figura Antideslizante Adhesiva para Bañera**

Figura de film de PVC con grabado en rombo antideslizante en forma de flor.

Adhesivo resistente al agua.

Color: Blanco

Tamaño: 115 x 155 mm

**Adhesive Non-slip Pattern for Bathtub**

PVC film figure with non-slip diamond engraving in the shape of a flower.

Adhesive resistant to water.

Colour: White

Size: 115 x 155 mm

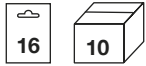

Ref.	Código Barras Bar Code
B60140B	8421196100657

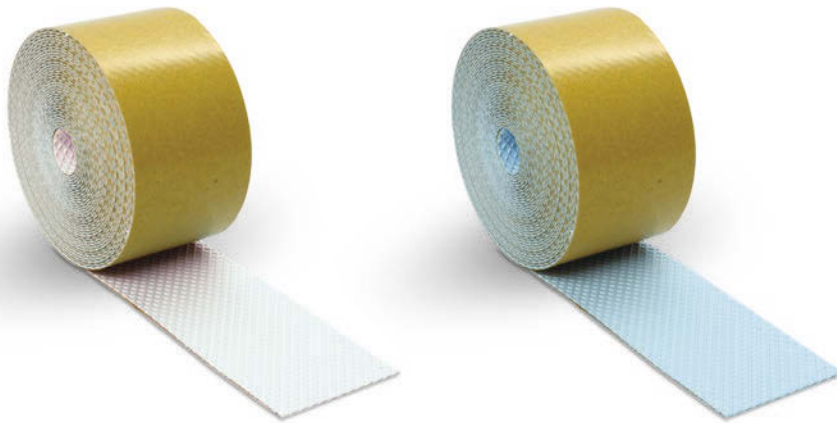
**Cinta Antideslizante Adhesiva para Bañera**

Film de PVC con grabado en rombo antideslizante.

Adhesivo resistente al agua.

Tamaño: 40 mm x 5 m

**Non-Slip Adhesive Tape for Bathtub**

PVC film with non-slip diamond engraving.

Adhesive resistant to water.

Size: 40 mm x 5 m

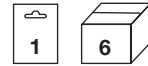

Ref.	Color Colour	Código Barras Bar Code
B60160B	Blanco White	8421196116740
B60160C	Azul Blue	8421196116757

**Antideslizante Granulado Adhesivo.****Especial Agua**

Cinta antideslizante "especial agua".

Superficie granulada de gran adherencia.

Adhesivo acrílico especial para uso en superficies húmedas.

Dimensiones: 40 mm x 5 m

**Non-Slip Adhesive Tape. Resistant to water**

Non-slip tape resisting to water.

Granular surface with excellent adhesion.

Acrylic adhesive special for use with wet surfaces.

Size: 40 mm x 5 m



Ref.	Acabado Finish	Código Barras Bar Code
B60170B	Blanco White	8421196117518
B60170H	Transparente Transparent	8421196117525





# Accesorios para Muebles

## Furniture Accessories

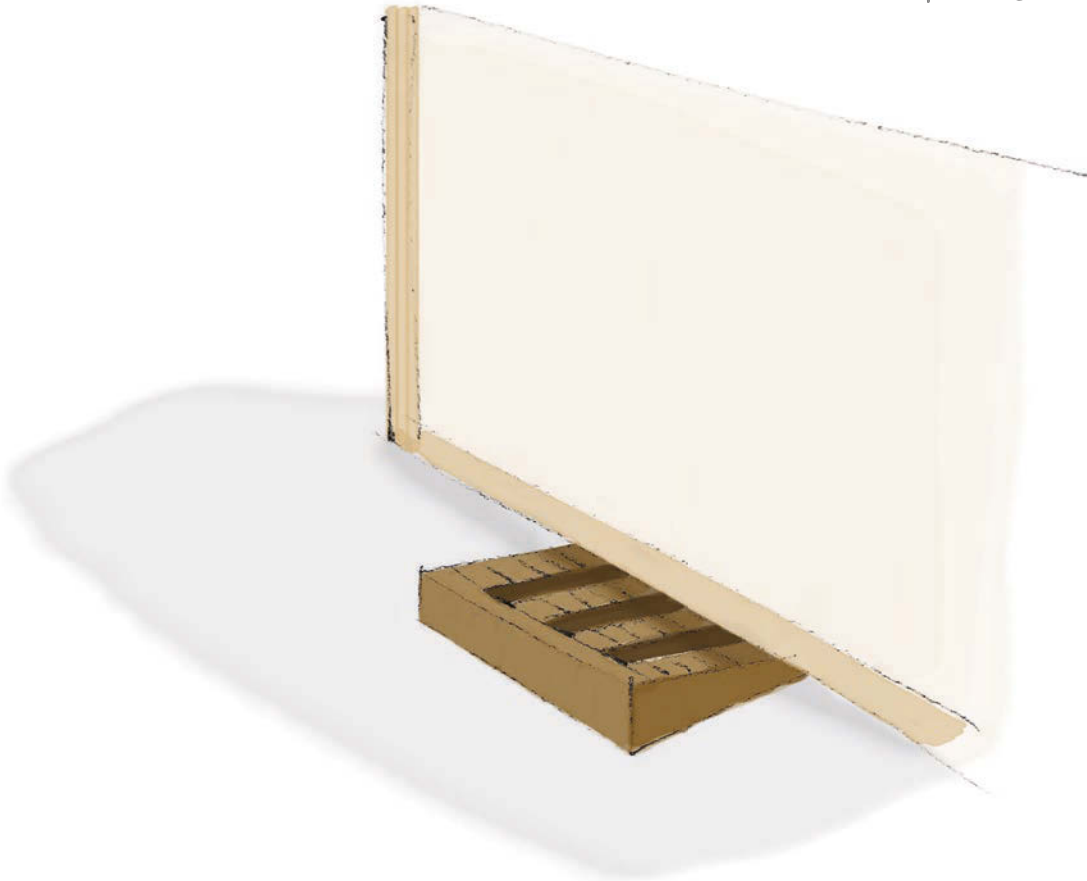

Embellecedor Cubre Tornillos Adhesivo <i>Adhesive Cover Caps</i> .....	146
Canto Embellecedor <i>Edge Band</i> .....	147
Gotas Protectoras Adhesivas <i>Adhesive Bumpers</i> .....	148
Protector Transparente Adhesivo <i>Transparent Adhesive Protectors</i> .....	149
Gotas Cónicas Protectoras Adhesivas <i>Adhesive Protector Conic Drops</i> .....	149
Gotas Planas Protectoras Adhesivas <i>Adhesive Protector Flat Drops</i> .....	149
Protector Espuma Adhesivo <i>Adhesive Foam Protector</i> .....	150
Topes Protectores de PVC <i>Adhesive PVC Protectors</i> .....	150
Cuñas Plástico <i>Plastic Door Wedges</i> .....	151
Cuñas Madera Haya <i>Wooden Door Wedges</i> .....	151
Antideslizante de Caucho Adhesivo <i>Non-slip Adhesive Protectors</i> .....	152
Protector de Espuma Adhesivo <i>Adhesive Foam Protector</i> .....	152



### Embellecedor Cubre Tornillos Adhesivo

Embellecedor para cubrir las cabezas de los tornillos  
Presentación: 30 discos Ø 13 mm

### Adhesive Cover Caps

Adhesive covers for screw heads.  
Presentation : 30 disks Ø 13 mm

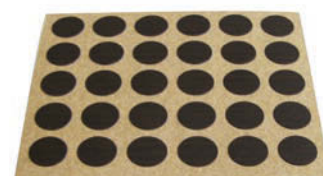
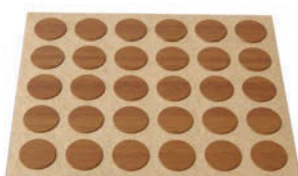
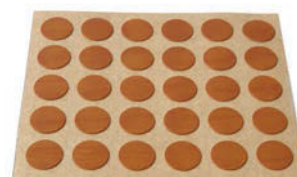
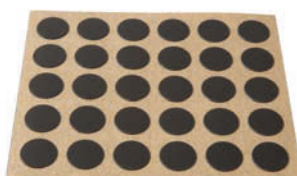

Ref.	Acabado Finish		Código Barras Bar Code
B77900B	Blanco White	25	8421196113435
B77900G	Gris Grey	10	8421196113442
B77900N	Negro Black	10	8421196114609
B77900X	Madera Pino Pine wood	10	8421196113459
B77900H	Madera Haya Beech wood	10	8421196114616
B77900Y	Madera Roble Oak wood	10	8421196113466
B77900C	Madera Cerezo Cherry wood	10	8421196115088
B77900O	Madera Nogal Walnut wood	10	8421196113473
B77900Z	Madera Sapeli Sapele wood	10	8421196113480
B77900W	Madera Wengue Wengue wood	10	8421196118652



**Canto Embellecedor**

Canto embellecedor de melamina para paneles de contrachapado. Modelos Preencolado para aplicar con plancha y Autoadhesivo para aplicar sin calor.

**Edge Band**

Edge band for wooden panels. Pre-glued model for Iron heat application and Self-adhesive to apply without heat.

Blanco White
Gris Grey
Negro Black
Madera Pino Pine wood
Madera Haya Beech wood
Madera Roble Oak wood
Madera Cerezo Cherry wood
Madera Nogal Walnut wood
Madera Sapeli Sapele wood
Madera Wengué Wengue wood

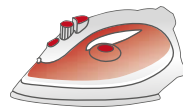

Ancho / Width: 22 mm  
Longitud / Length: 5 m

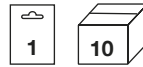

**Preencolado / Pre-glued**

Ref.	Acabado Finish	Código Barras Bar Code
B77950B	Blanco White	8421196119598
B77950G	Gris Grey	8421196119604
B77950N	Negro Black	8421196119611
B77950X	Madera Pino Pine wood	8421196119628
B77950H	Madera Haya Beech wood	8421196119635
B77950Y	Madera Roble Oak wood	8421196119642
B77950C	Madera Cerezo Cherry wood	8421196119659
B77950O	Madera Nogal Walnut wood	8421196119666
B77950Z	Madera Sapeli Sapele wood	8421196119673
B77950W	Madera Wengué Wengue wood	8421196119680



Ancho / Width: 19 mm  
Longitud / Length: 5 m



**Autoadhesivo / Self-Adhesive**

Ref.	Acabado Finish	Código Barras Bar Code
B77970B	Blanco White	8421196120341
B77970G	Gris Grey	8421196120358
B77970N	Negro Black	8421196120365
B77970X	Madera Pino Pine wood	8421196120372
B77970H	Madera Haya Beech wood	8421196120389
B77970Y	Madera Roble Oak wood	8421196120396
B77970C	Madera Cerezo Cherry wood	8421196120402
B77970O	Madera Nogal Walnut wood	8421196120419
B77970Z	Madera Sapeli Sapele wood	8421196120426
B77970W	Madera Wengué Wengue wood	8421196120433



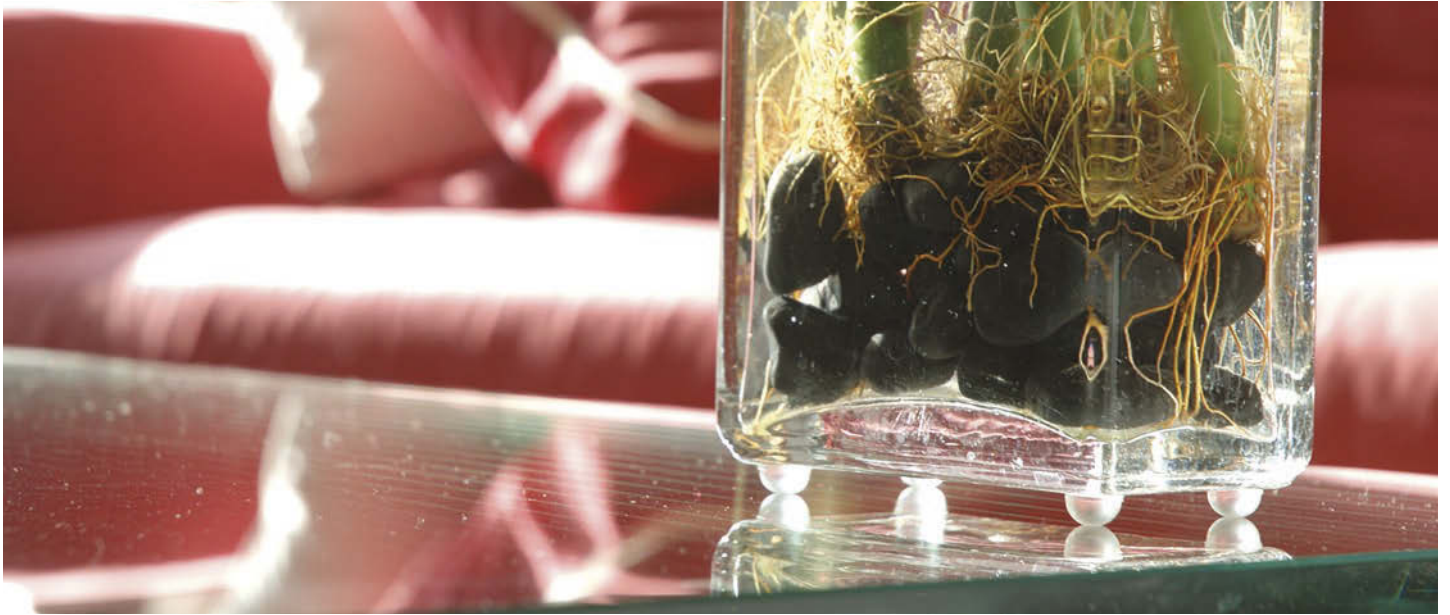

### Gotas Protectoras Adhesivas

Gotas protectoras adhesivas fabricadas en PVC transparente. Diseñado como protector de objetos y amortiguador de puertas de armario.

### Adhesive Bumpers

Adhesive protector drops made in transparent PVC. Designed as shock absorbers for objects and wardrobe doors.

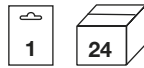

Ref.	Medidas Pastilla Drop Size	Placa con... Sheet with...	Código Barras Bar Code
B70620H	Ø 9 mm x 2 mm	25 pastillas 25 drops	8421196102781
B70630H	Ø 12 mm x 2,5 mm	16 pastillas 16 drops	8421196102859
B78020H	Ø 10 mm x 5 mm	25 pastillas 25 drops	8421196108554
B78030H	Ø 12 mm x 6 mm	16 pastillas 16 drops	8421196108561

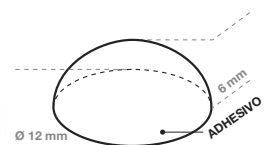
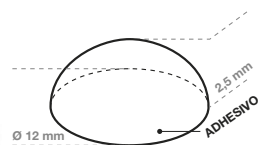
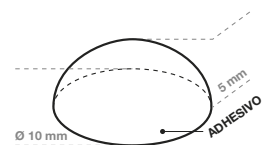
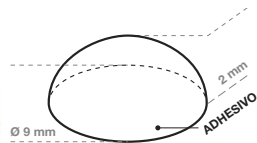



### Protector Transparente Adhesivo

Protector adhesivo troquelado fabricado en PVC transparente.

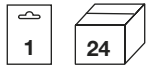

### Transparent Adhesive Bumpers

Adhesive protectors in pre-cut transparent PVC.



Ref.	Medidas Pastilla Drop Size	Placa con... Sheet with...	Código Barras Bar Code
B78000H	15 x 15 x 5 mm	16 cuadrados 16 squares	8421196117426
B78010H	20 x 20 x 4,5 mm	9 cuadrados 9 squares	8421196117433



### Gotas Cónicas Protectoras Adhesivas

Gotas protectoras adhesivas fabricadas en PVC transparente. Diseñado como protector de objetos y amortiguador de puertas de armario. Color: Transparente.

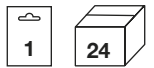

### Conical Adhesive Bumpers

Conic adhesive protector drops in transparent PVC. Used as object protectors and shock absorbers of wardrobe doors. Colour: Transparent.



Ref.	Medidas Pastilla Drop Size	Placa con... Sheet with...	Código Barras Bar Code
B78040H	Ø 16 x 8 mm	9 pastillas 9 drops	8421196117761



### Gotas Planas Protectoras Adhesivas

Gotas protectoras adhesivas fabricadas en PVC transparente. Diseñado como protector de objetos y amortiguador de puertas de armario. Color: Transparente.



### Flat Adhesive Bumpers

Flat adhesive protector drops in transparent PVC. Used as object protectors and shock absorbers of wardrobe doors. Colour: Transparent.



Ref.	Medidas Pastilla Drop Size	Placa con... Sheet with...	Código Barras Bar Code
B78050H	Ø 17 x 3 mm	9 pastillas 9 drops	8421196117846





**Protector Espuma Adhesivo**

Espuma de PVC de 2 mm de espesor.  
Adhesivo acrílico.  
Color: Blanco  
Ancho: 40 mm

**Adhesive Foam Protector**

2 mm thickness PVC foam.  
Acrylic adhesive.  
Colour: White  
Width: 40 mm

Ref.	Longitud Length			Código Barras Bar Code
B62610B	1 m	1	10	8421196111974
B62635B	10 m	x	5	8421196112018

**Topes Protectores de PVC**

Protector adhesivo fabricado en PVC. Ideal como protector de golpes de objetos, manetas de puertas...

**Adhesive PVC Protectors**

PVC self-adhesive shock absorber. Ideal to protect objects from crashes.



Ref.	Medidas Pastilla Drop Size	Placa con... Sheet with...	Color Colour	Código Barras Bar Code
B70600B	15 x 15 x 5 mm	16 cuadrados 16 squares	Blanco White	8421196102668
B70600M			Marrón Brown	8421196102675
B70610B	20 x 20 x 4,5 mm	9 cuadrados 9 squares	Blanco White	8421196102682
B70610M			Marrón Brown	8421196102699





### Cuñas Plástico Madera

Cuñas de plástico en color imitación madera.  
Incluye marcas antideslizantes para un perfecto anclaje.

#### Plastic Door Wedges

Imitation wood plastic door wedges.  
They have got non-slip marks to get a perfect keeping up.



Ref.	Tamaño Size	Código Barras Bar Code
B78500Z	Pequeña / Small 50 x 30 x 7 mm	8421196116313
B78510Z	Mediana / Medium 66 x 30 x 15 mm	8421196116320
B78520Z	Grande / Large 80 x 30 x 20 mm	8421196120204



### Cuñas Plástico Transparente

Cuñas de plástico en color transparente.  
Incluye marcas antideslizantes para un perfecto anclaje.

#### Transparent Plastic Wedges

Wedges in clear plastic.  
Includes skid marks for a perfect anchorage.



Ref.	Tamaño Size	Código Barras Bar Code
B78500H	Pequeña / Small 50 x 30 x 7 mm	8421196120167
B78510H	Mediana / Medium 66 x 30 x 15 mm	8421196120181
B78520H	Grande / Large 80 x 30 x 20 mm	8421196120211



### Cuñas Madera Haya

Cuñas de madera de haya natural.

#### Wooden Door Wedges

Door wedges made in beech wood.



Ref.	Tamaño Size	Código Barras Bar Code
B78600H	Pequeña / Small 50 x 30 x 7 mm	8421196116337
B78610H	Mediana / Medium 66 x 30 x 15 mm	8421196116344
B78620H	Grande / Large 80 x 30 x 20 mm	8421196120273





**Antideslizante de Caucho Adhesivo**  
Protector de espuma antideslizante adhesivo troquelado fabricado en espuma de color negro.

**Non-slip Adhesive Protectors**  
Non-slip adhesive foam protector.  
Colour: Black

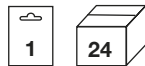

Ref.	Medidas Pastilla Drop Size	Placa con... Sheet with...	Código Barras Bar Code
B78100N	100 x 85 mm	1 rectángulo 1 square	8421196103320
B78120N	16 x 20 mm	16 rectángulos 16 squares	8421196103344
B78170N	Ø 16 mm	20 discos 20 discs	8421196103399

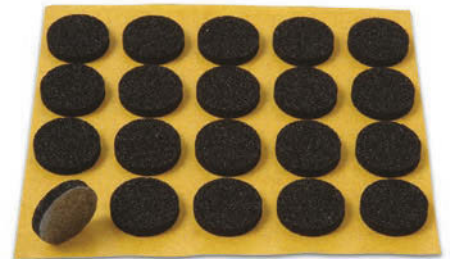

**Protector de Espuma Adhesivo**  
Protector de espuma antideslizante en rollo.  
Espuma de PVC de 5 mm de espesor.  
Adhesivo acrílico.  
Ancho 15 mm  
Longitud: 10 m (2 x 5 m)

**Adhesive Foam Protector**  
Non-slip adhesive foam protector roll.  
PVC foam of 5 mm thickness.  
Width: 15 mm  
Length: 10 m (2 x 5 m)



Ref.	Color Colour	Código Barras Bar Code
B82600N	Negro Black	8421196123458



# Bricolaje y Accesorios para el Hogar

## DIY and Home Accessories

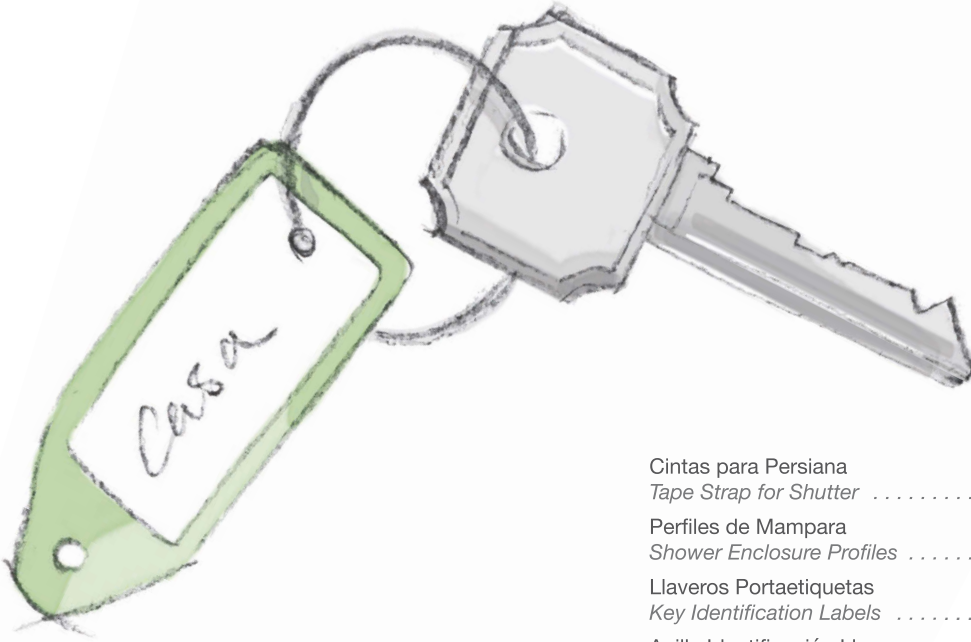

Cintas para Persiana <i>Tape Strap for Shutter</i> .....	154
Perfiles de Mampara <i>Shower Enclosure Profiles</i> .....	156
Llaveros Portaetiquetas <i>Key Identification Labels</i> .....	158
Anilla Identificación Llaves <i>Key Identification Ring</i> .....	159
Etiqueta Magnética <i>Magnetic Label</i> .....	160
Imán Adhesivo <i>Adhesive Magnet</i> .....	160
Imanes de Ferrita <i>Ferrite Magnets</i> .....	161
Imanes de Neodimio <i>Neodymium Magnets</i> .....	161
Rascador y Hojas de recambio <i>Scraper and Replacement Blades</i> .....	162
Rascavidrios y Hojas de recambio <i>Glass Scrapers and Replacement Blades</i> .....	163
Sujetamanteles <i>Tablecloth Clips</i> .....	164
Abrelatas <i>Can Opener</i> .....	165
Abridor Plano <i>Flat Bottle Opener</i> .....	165
Pinchos <i>Barbecue and Snail Skewers</i> .....	165
Filtros para Sumidero <i>Sink Strainers</i> .....	166
Sujetacables <i>Wire Holders</i> .....	167
Tiras Adhesivas de Cierre Téxtil <i>Hook &amp; Loop self-adhesive Strips</i> .....	168
Discos Adhesivos de Cierre Téxtil <i>Hook &amp; Loop self-adhesive Discs</i> .....	169
Brida de Cierre Téxtil <i>Hook &amp; Loop Fastener Strip</i> .....	169
Cinta de Cierre Téxtil <i>Hook &amp; Loop Fastener Roll</i> .....	169
Marcadores Permanentes <i>Permanent Markers</i> .....	170



Ref.	Longitud Length	Color Colour			Código Barras Bar Code
B61050G	5 m (para ventanas) (for windows)	Gris Grey	1	10	8421196100596
B61050Q		Beige Beige			8421196100602
B61060G	6 m (para puertas) (for doors)	Gris Grey	1	10	8421196100619
B61060Q		Beige Beige			8421196100626
B61045G	50 m	Gris Grey	x	1	8421196100572
B61045Q		Beige Beige			8421196100589

**Cinta para Persiana. 13 mm**

Cinta para persiana de microfibra entrelazada. Gran durabilidad y resistencia. Acabado brillante. Medida utilizada en cajones externos abatibles. Ancho: 13 mm

**Tape Strap for Shutter. 13 mm**

Tape strap for shutter in interlaced microfibre. High resistance and long lasting life. Shiny finish. Measure used for external boxes. Width: 13 mm

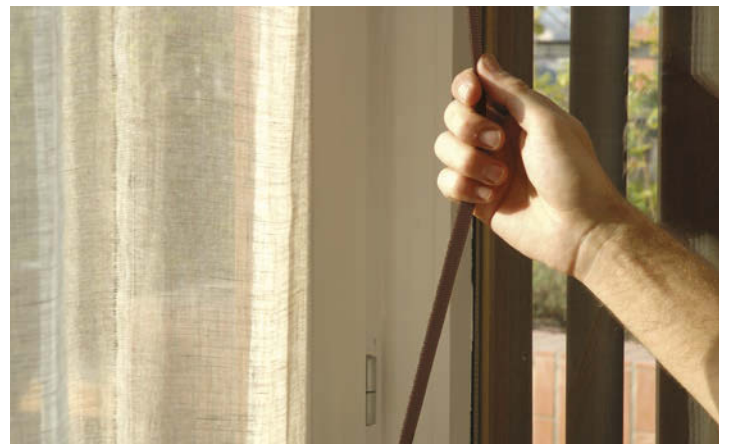
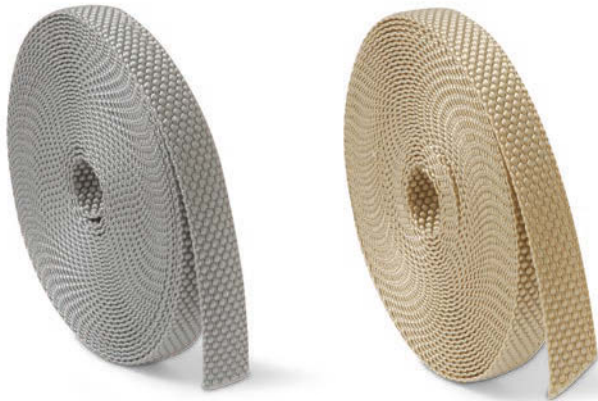
**Cinta para Persiana. 18 mm**

Cinta para persiana de microfibra entrelazada. Alta resistencia y gran durabilidad. Acabado brillante. Color y tamaños apropiados para carpintería de aluminio. Ancho 18 mm. Espesor 1,6 mm

**Tape Strap for Shutter. 18 mm**

Tape strap for shutter in interlaced microfibre. High resistance and long lasting life. Shiny finish. Colour and sizes suitable for aluminium carpentry. Width: 18 mm. Thickness 1.6 mm

Ref.	Longitud Length	Color Colour			Código Barras Bar Code
B61530B	6 m	Blanco White	1	10	8421196117600
B61530I		Bronce Bronze			8421196117617
B61515B	50 m	Blanco White	x	1	8421196117563
B61515I		Bronce Bronze			8421196117570



**Cinta para Persiana. 22 mm**

Cinta para persiana de microfibra entrelazada.  
Alta resistencia y gran durabilidad.  
Acabado brillante.  
Ancho 22 mm

**Tape Strap for Shutter. 22 mm**

Tape strap for shutter in interlaced microfibre.  
High resistance and long lasting life.  
Shiny finish.  
Width: 22 mm



Ref.	Longitud Length	Color Colour			Código Barras Bar Code
B61020G	5 m (para ventanas) (for windows)	Gris Grey	1	10	8421196100534
B61020Q		Beige Beige			8421196100541
B61020X		Bicolor Bicolour			8421196125216
B61030G	6 m (para puertas) (for doors)	Gris Grey	1	10	8421196100558
B61030Q		Beige Beige			8421196100565
B61030X		Bicolor Bicolour			8421196125223
B61015G	50 m	Gris Grey	x	1	8421196100510
B61015Q		Beige Beige			8421196100527
B61015X		Bicolor Bicolour			8421196125209





### Perfiles para Mampara

Perfiles transparentes bicomponente para un correcto cierre de las mamparas y cristaleras.  
Medidas 6 a 8 mm para mamparas de baño.  
Medidas 8 a 10 mm para puertas acristaladas.

### Shower Enclosure Profiles

Transparent bicomponent profiles for a correct closure of the shower doors.

Measures 6 to 8 mm for bathroom enclosures.  
Measures 8 to 10 mm for glass doors.



### Mampara Lateral · Lateral enclosure

Ref.	Espesor Thickness	Tamaño Size		Código Barras Bar Code
B603055	6 ~ 8 mm	200 cm	10	8421196122888
B603355	8 ~ 10 mm	200 cm	10	8421196123151

### Mampara Inferior · Bottom enclosure

Ref.	Espesor Thickness	Tamaño Size			Código Barras Bar Code
B603104	6 ~ 8 mm	100 cm	1	10	8421196122956
B603155	6 ~ 8 mm	200 cm	x	10	8421196122895



### Mampara Inferior Largo · Large Bottom enclosure

Ref.	Espesor Thickness	Tamaño Size			Código Barras Bar Code
B603704	6 ~ 8 mm	100 cm	1	10	8421196125834
B603755	6 ~ 8 mm	200 cm	x	10	8421196125841





**Mampara Corredera · Sliding doors**

Ref.	Espesor Thickness	Tamaño Size			Código Barras Bar Code
B603255	6 ~ 8 mm	200 cm	x	10	8421196122901



**Mampara Abatible · Folding Profile enclosure**

Ref.	Espesor Thickness	Tamaño Size			Código Barras Bar Code
B603655	6 ~ 8 mm	200 cm	x	10	8421196125827

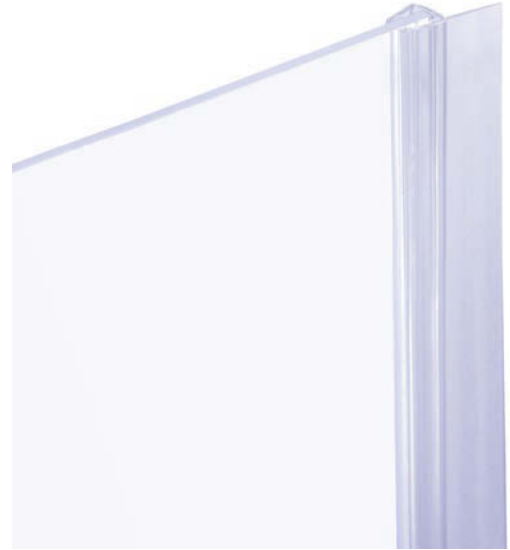

**Mampara Recta Con Imán · Magnetic lineal doors**

Ref.	Espesor Thickness	Tamaño Size			Código Barras Bar Code
B603455	6 ~ 8 mm	200 cm	x	10	8421196123168



**Mampara Esquina Con Imán · Magnetic corner doors**

Ref.	Espesor Thickness	Tamaño Size			Código Barras Bar Code
B603555	6 ~ 8 mm	200 cm	x	10	8421196123175



**Llavero Portaetiquetas**

Llavero portaetiquetas en colores para una fácil identificación de las llaves. Incluye lámina de papel y film protector para una mayor durabilidad de la escritura.

Tamaño: 59 x 23 mm

**Key Identification Label**

Colour plastic tags for an easy key identification. It includes a blade of paper and protector film to get a long lasting inscription.

Size: 59 x 23 mm



Ref.	Presentación Packaging		Color Colour	Código Barras Bar Code
B501100	Display 8 unidades Blister 8 units	10	8 Colores 8 Colours	8421196100350
B501140	Expositor 200 unidades Exhibitor 200 units	1	8 Colores 8 Colours	8421196100367
B501150	Bolsa con 125 unidades Bag 125 units	1	5 Colores 5 Colours	8421196117693
B50115B	Bolsa con 50 unidades Bag 50 units	1	Blanco White	8421196103269
B50115N			Negro Black	8421196103276
B50115T			Naranja Orange	8421196103313
B50115G			Gris Grey	8421196103306
B50115C			Azul Blue	8421196103290
B50115V			Verde Green	8421196103351
B50115R			Rojo Red	8421196103337
B50115A			Amarillo Yellow	8421196103283



### Llavero Portaetiquetas. Grande

Llavero portaetiquetas en colores para una fácil identificación de las llaves.  
Incluye lámina de papel y film protector para una mayor durabilidad de la escritura.  
Tamaño: 63 x 39 mm

#### Key identification Label. Large

Colour plastic tags for an easy key identification.  
It includes a blade of paper and protector film for more long-lasting inscription.  
Size: 63 x 39 mm



Ref.	Color Colour	Código Barras Bar Code
B50125B	Blanco White	8421196103368
B50125N	Negro Black	8421196103375
B50125T	Naranja Orange	8421196103436
B50125G	Gris Grey	8421196103412
B50125C	Azul Blue	8421196103405
B50125V	Verde Green	8421196103498
B50125R	Rojo Red	8421196103467
B50125A	Amarillo Yellow	8421196103382



### Anilla Identificación Llaves

Anilla de goma para identificar las llaves por color.  
Tamaño: Ø 26 mm

#### Key Identification Ring

Rubber ring to identify keys by Colour.  
Size: Ø 26 mm

Ref.	Presentación Packaging		Color Colour	Código Barras Bar Code
B500700	Display 8 unidades Blister 8 units	10	8 Colores 8 Colours	8421196100305
B500740	Expositor 400 unidades Exhibitor 400 units	1	8 Colores 8 Colours	8421196105232
B50075B	Bolsa con 50 unidades Bag 50 units	1	Blanco White	8421196105195
B50075N			Negro Black	8421196101241
B50075T			Naranja Orange	8421196105324
B50075G			Gris Grey	8421196104099
B50075C			Azul Blue	8421196105638
B50075V			Verde Green	8421196104105
B50075R			Rojo Red	8421196105218
B50075A			Amarillo Yellow	8421196104587







### Etiqueta Magnética

Etiqueta magnética con papel y film protector. Ideal para la colocación en estanterías metálicas. Gracias a su papel reemplazable y a su anclaje por imán, permite una rápida reorganización de estanterías. Color negro.

Ancho: 25 mm

Presentación: Caja Expositor de 30 unidades.

### Magnetic Label

Magnetic label with paper and protector film. Ideal to store in a set of shelves. Due to its renewable paper and its magnetic surface, this label allows a quick reorganization of the storage.

Width: 25 mm

Presentation: 30 units display box.

Ref.	Longitud Length	Código Barras Bar Code
B42305N	10 cm	8421196111998
B42315N	20 cm	8421196111981



### Imán Adhesivo

Imán flexible adhesivado por una de sus caras. Múltiples aplicaciones, para pizarras magnéticas, decoración para neveras...  
Color: Negro.

### Adhesive Magnet

Self-adhesive flexible magnet. Multiple applications, for magnetic boards, decoration for refrigerators...  
Colour: Black.



Ref.	Tamaño Size	Espesor Thickness		Código Barras Bar Code
B42800N	Rollo / Roll 20 mm x 1 m	1,2 mm	10	8421196123328
B42810N	Placa / Sheet 100 x 85 mm	0,6 mm	15	8421196123335



### Imanes de Ferrita

Imanes fabricados en Ferrita, utilizados en múltiples aplicaciones como automatización, control, medición... Magnetización permanente. Uso en interior y exterior. Resistente a muchas sustancias químicas, como por ejemplo a disolventes, lejías y ácido fluorhídrico.



Ref.	Tamaño Size	Gauss		Código Barras Bar Code
B42500F	24 x 12 x 5 mm con agujero / with hole	1160	12	8421196122550
B42510F	40 x 20 x 10 mm	1360	2	8421196122567

### Ferrite Magnets

Magnets manufactured in Ferrite, used in multiple applications such as automation, control, measurement... Permanent magnetization. Indoor and outdoor use. Resistant to many chemicals such as solvents, lyes and hydrofluoric acid.



### Imanes de Neodimio. Rectangulares

Los imanes de neodimio representan la última generación de los materiales magnéticos. Poseen propiedades muy superiores a las tradicionales siendo actualmente los más potentes del mercado.



Ref.	Tamaño Size	Gauss		Código Barras Bar Code
B42600N	20 x 15 x 1,5 mm	928	12	8421196122574
B42610N	20 x 20 x 5 mm	2478	6	8421196122581
B42620N	30 x 10 x 1,5 mm	1158	12	8421196125998
B42630N	40 x 20 x 10 mm	2350	2	8421196122604

### Neodymium magnets. Rectangular

Neodymium magnets represent the latest generation of magnetic materials. They have better properties than traditional ones being currently the most powerful ones of the market.



### Imanes de Neodimio. Discos

Los imanes de neodimio representan la última generación de los materiales magnéticos. Poseen propiedades muy superiores a las tradicionales siendo actualmente los más potentes del mercado.



Ref.	Tamaño Size	Gauss		Código Barras Bar Code
B42700N	Ø 9,5 x 1,5 mm	1642	12	8421196122611
B42710N	Ø 15 x 3 mm	2247	12	8421196122628
B42720N	Ø 20 x 5 mm	2706	6	8421196122635
B42730N	Ø 22 x 10 mm	4070	4	8421196123205
B42740N	Ø 14 x 4,5 x 3 mm	3080	12	8421196123212

### Neodymium magnets. Round

Neodymium magnets represent the latest generation of magnetic materials. They have better properties than traditional ones being currently the most powerful ones of the market.





### Rascador Profesional

Rascador de acero con cuchilla de acero templado.  
Color: Gris

Ref.	Código Barras Bar Code
B42060G	8421196115132



### Professional Scraper

Steel scraper with tempered steel blade.  
Colour: Grey

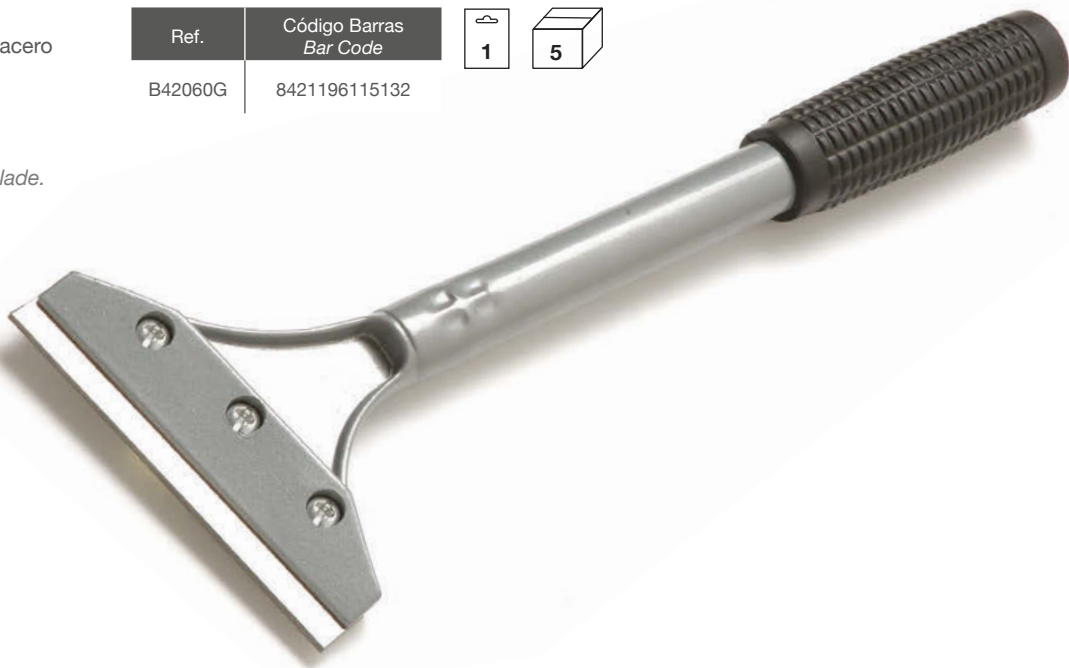

### Recambio para Rascador Profesional

Caja de 5 hojas de recambio para Rascador Ref. B42060G.  
Acero templado

### Replacement for Professional Scraper

Plastic case with 5 blades for Scraper Item No. B42060G  
Tempered steel.



Ref.	Tamaño Hoja Blade Size	Código Barras Bar Code
B42070E	100 x 14 mm	8421196122369





### Rascavidrios con Mango

Rascavidrios de plástico con cuchilla de acero templada y mango.

#### Glass Scraper with Sleeve

Plastic glass scraper with a tempered steel blade and a sleeve

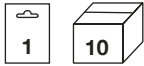

Ref.	Color Colour	Código Barras Bar Code
B42020N	Negro Black	8421196101630



### Recambio para Rascavidrios con Mango

Caja de 10 hojas de recambio para Rascavidrios Ref. B42020N. Cuchillas de acero templado.

#### Replacement for Glass Scraper with Sleeve

Box of 10 spare blades for Glass Scraper Item No. B42020N. Tempered steel blades.

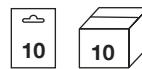

Ref.	Código Barras Bar Code
B42040E	8421196114623

### Rascavidrios Plano

Rascavidrios de plástico con cuchilla de acero templado.

#### Flat Glass Scraper

Plastic glass scraper with a tempered steel blade.

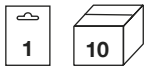

Ref.	Color Colour	Código Barras Bar Code
B42030C	Azul Blue	8421196101661



### Recambio para Rascavidrios Plano

Caja de 10 hojas de recambio para Rascavidrios Ref. B42030C. Cuchillas de acero templado.

#### Replacement for Flat Glass Scraper

Box of 10 spare blades for Glass Scraper Item No. B42030C. Tempered steel blades



Ref.	Código Barras Bar Code
B42050E	8421196114630



### Sujetamanteles Acero Inoxidable

Sujetamanteles flexible fabricado en Acero Inoxidable.

#### Stainless Steel Tablecloth Clip

Flexible stainless steel tablecloth clip.

Ref.	Código Barras Bar Code
B70200E	8421196101067



### Sujetamanteles Plástico

Sujetamanteles flexible de una pieza fabricado en plástico ABS.

#### Plastic Tablecloth Clip

Flexible tablecloth clip made in one ABS plastic piece.

Ref.	Acabado Finish	Código Barras Bar Code
B50100B	Blanco White	8421196100312
B50100H	Transparente Transparent	8421196123199



### Sujetamanteles con Muelle

Sujetamanteles de plástico articulado con muelle para espesores de mesa de hasta 70 mm. Color: Blanco.

#### Tablecloth Clip with Spring

Plastic tablecloth clip, articulated by a spring for a thickness table up to 70 mm. Colour: White

Ref.	Código Barras Bar Code
B50090B	8421196117037



### Abrelatas

Abrelatas tipo "explorador" fabricado en Acero Inoxidable. Contiene hoja de corte afilado.

#### Can Opener

"Explorer" Can opener with a sharp blade.



Ref.	Código Barras Bar Code
B70370E	8421196101609



### Abridor Plano

Abridor plano de botella. Cromado.

#### Flat Bottle Opener

Bottle opener. Flat shape. Chrome.



Ref.	Código Barras Bar Code
B70020J	8421196100664



### Pincho Caracoles. Inox

Pincho de Acero Inoxidable con la punta afilada para caracoles. Medidas: Ø 2 mm - 10 cm

#### Snail Skewer. Stainless Steel

Little stainless steel skewer with a sharp tip for snails. Size: Ø 2 mm - 10 cm

Ref.	Código Barras Bar Code
B80000E	8421196108097



### Pincho Acero Inoxidable

Pincho Acero Inoxidable con la punta afilada para alimentos.

#### Stainless Steel Skewer

Stainless steel skewer with a sharp for food.

Ref.	Tamaño Size	Código Barras Bar Code
B80010E	Ø 2,5 mm - 27 cm	8421196103580
B70170E	Ø 2,5 mm - 37 cm	8421196100961



### Pincho bambú

Pincho de un solo uso fabricado en madera de bambú para alimentos. Longitud: 25 cm

#### Bamboo Skewer

Single-use skewer made of bamboo wood for food. Length: 25 cm



Ref.	Código Barras Bar Code
B30060Z	8421196105270





**Filtro para Sumidero**

Filtro fabricado en Acero Inoxidable y lacado para colocar en el sumidero de baños, aseos y cocinas. Evita que los restos sólidos o cabellos obstruyan los desagües. Fácil limpieza. Su forma cónica y su diversidad en medidas permite que se ajuste fácilmente a cualquier tamaño de sumidero.

**Sink Strainer**

*Sink strainer in stainless steel and lacquered. To put in the kitchen, bathroom and toilets sink hole. It avoids that the solid rests or the hair blocks the drainages. Easy to clean. Its conical shape makes that it adapts itself easily to any size of drains.*

Ref.	Longitud Length	Color Colour	Código Barras Bar Code
B70030E	Pequeño / Small Ø 57 mm	Acero Inoxidable Stainless Steel	8421196100671
B70040E	Mediano / Medium Ø 64 mm	Acero Inoxidable Stainless Steel	8421196100688
B70040D		Lacado Blanco White Lacquered	8421196104761
B70930E	Grande / Large Ø 72 mm	Acero Inoxidable Stainless Steel	8421196107656
B70930D		Lacado Blanco White Lacquered	8421196107663

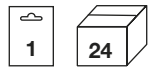
**Filtro para Sumidero. Plástico**

Filtro fabricado en TPR. Colocado con los picos hacia arriba sobre el sumidero de la cocina o de la ducha, evita que se cuelen restos de comida o cabellos en el desagüe al quedar retenidos o enredados en los picos.

Tamaño: Ø 130 mm

**Sink Strainer. Plastic**

*Sink strainer made of TPR. Placed with the spikes facing upwards the kitchen or shower drain, it prevents food debris or hair from passing the sink, as they are retained or entangled in the spikes.*

Size: Ø 130 mm

Ref.	Color Colour	Código Barras Bar Code
B50410B	Blanco White	8421196125407
B50410G	Gris Grey	8421196125414

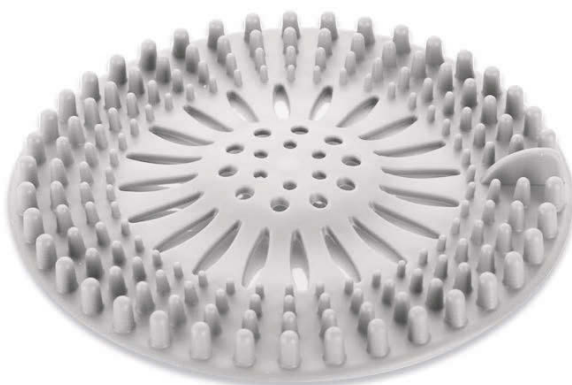
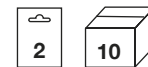

**Sujetacables Redondo. Adhesivo**

Sujetacables redondo pequeño y discreto para sujetar un cable.  
Fabricado en TPR con adhesivo en la base.  
Ranuras: 1  
Tamaño: Ø 28 x 15 mm

**Round Wire Holder. Adhesive**

Small and discreet round wire holder. Made of TPR with adhesive on the base.  
Slots: 1  
Size: Ø 28 x 15 mm

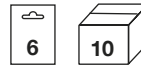

Ref.	Color Colour	Código Barras Bar Code
B44000B	Blanco White	8421196125322
B44000N	Negro Black	8421196125339
B440000	Surtido 3 colores Assortmet 3 colours	8421196125346



**Sujetacables Alargado. Adhesivo**

Sujetacables alargado para sujetar y organizar cables.  
Fabricado en TPR con adhesivo en la base.  
Ranuras: 4  
Tamaño: 22 x 65 mm

**Elongated Wire Holder. Adhesive**

Elongated wire holder. Made of TPR with adhesive on the base.  
Slots: 4  
Size: 22 x 65 mm

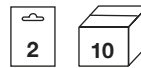

Ref.	Color Colour	Código Barras Bar Code
B44010B	Blanco White	8421196125353
B44010N	Negro Black	8421196125360



**Sujetacables Espiral**

Sujetacables espiral para enlazar o recoger varios cables.  
Fabricado en TPR.  
Tamaño: Ø 15 x 105 mm

**Spiral Wire Holder**

Small and discreet round wire holder. Made of TPR with adhesive on the base.  
Size: Ø 15 x 105 mm

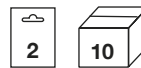

Ref.	Color Colour	Código Barras Bar Code
B44020B	Blanco White	8421196125377
B44020N	Negro Black	8421196125384
B440200	Surtido 2 colores Assortmet 2 colours	8421196125391





### Tiras Adhesivas de Cierre Téxtil

Sistema de apertura y cierre rápido formado en un lado por micro-anclajes extruidos de plástico que se agarran al otro lado formado por un entramado de fibras. Proporciona un agarre resistente a la vez que removible y reutilizable. Lados externos con adhesivo acrílico. Resistente a Rayos UV, agua y humedad. Ancho: 20 mm

### Hook & Loop self-adhesive Strips

Quick opening and closing system. One side formed by extruded plastic micro-hooks that attach to the other side, a fabric mesh in the form of loops. These two components join to give a grip that is strong while being removable and re-usable. The outer sides of fabric contain acrylic adhesive for a firm bond. Resistant to UV rays, water and moisture. Width: 20 mm

Ref.	Longitud Length	Color Colour			Código Barras Bar Code
B42400B	10 cm	Blanco White	4	10	8421196118683
B42400N		Negro Black			8421196117754
B42410B	Rollo de 1,5 m Roll of 1.5 m	Blanco White	1	10	8421196118492
B42410N		Negro Black			8421196117778
B42420B	Rollo de 25 m Roll of 25 m	Blanco White	1	1	8421196118812
B42420N		Negro Black			8421196118089





### Discos Adhesivos de Cierre Téxtil

Discos textiles formados en un lado por micro-anclajes extruidos de plástico que se agarran al otro lado formado por un entramado de fibras. Proporciona un agarre resistente a la vez que removible y reutilizable. Lados externos con adhesivo acrílico.  
Tamaño: Ø 18 mm

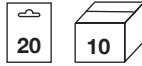

Ref.	Color Colour	Código Barras Bar Code
B42430B	Blanco White	8421196124370
B42430N	Negro Black	8421196124387

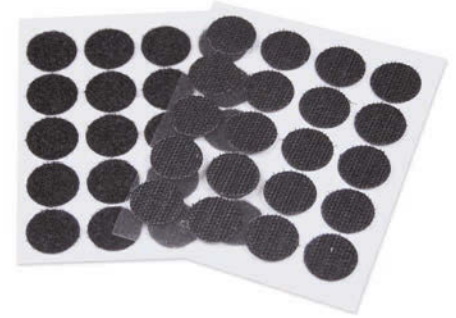

### Hook & Loop self-adhesive Discs

Quick opening and closing system. One side formed by extruded plastic micro-hooks that attach to the other side, a fabric mesh in the form of loops. These two components join to give a grip that is strong while being removable and re-usable. The outer sides of fabric contain acrylic adhesive for a firm bond.  
Size: Ø 18 mm



### Brida de Cierre Téxtil

Tira téxtil formada en un lado por microanclajes extruidos que se agarran al lado opuesto formado por un entramado de fibras. Ideal para recoger cables, y uniones temporales de objetos. Incluye orificio para formar una vaga que permite dejar atada la brida cuando esta está abierta.  
Tamaño: 12 mm x 20 cm

### Hook & Loop Fastener Strip

Strip made by extruded micro-hooks that attach to the other side, a fabric mesh in the form of loops. Suitable for picking cables, and temporary joints of objects. It includes hole to form a space that allows to leave tied the strip when it is open.  
Size: 12 mm x 20 cm

Ref.	Color Colour	Código Barras Bar Code
B42460N	Negro Black	8421196124417
B424600	Surtido 6 colores Assortment 6 colours	8421196124400

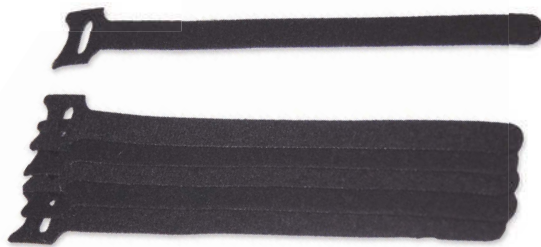
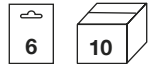

### Cinta de Cierre Téxtil

Rollo téxtil formado en un lado por microanclajes extruidos que se agarran al lado opuesto formado por un entramado de fibras. Ideal para recoger cables, y uniones temporales de objetos.  
Tamaño: 12 mm x 3 m

### Hook & Loop Fastener Roll

Strip made by extruded micro-hooks that attach to the other side, a fabric mesh in the form of loops. Suitable for picking cables, and temporary joints of objects. It includes hole to form a space that allows to leave tied the strip when it is open.  
Size: 12 mm x 3 m

Ref.	Color Colour	Código Barras Bar Code
B42470B	Blanco White	8421196124424
B42470N	Negro Black	8421196124431
B42470V	Verde Green	8421196124448





**Marcador Permanente Doble Punta**

Marcador permanente para escritura sobre todo tipo de superficies: cristal, metal, madera, plástico... No daña la película plástica de los CD y DVD. Punta Fina y Punta Extra Fina.

**Double-ended Permanent Marker**

Permanent marker to write on all kind of surface: crystal, metal, plastic... Does not damage the CD and DVD surface. Fine tip and Extra Fine tip.

Ref.			Color Colour	Código Barras Bar Code
B42120N			Negro Black	8421196117723
B42120R	1	10	Rojo Red	8421196117730
B42120C			Azul Blue	8421196117747
B421200	3	10	Surtido 3 colores Assortment 3 colours	8421196117716



**Marcador Permanente Punta Gruesa**

Marcador permanente para escritura sobre todo tipo de superficies: cristal, metal, madera, plástico...  
Punta: 2 mm

**Thick-tipped Permanent Marker**

Permanent marker to write on all kind of surface: crystal, metal, plastic...  
Tip: 2 mm

Ref.			Color Colour	Código Barras Bar Code
B42130N			Negro Black	8421196119130
B42130R	1	10	Rojo Red	8421196119147
B42130C			Azul Blue	8421196119123
B421300	3	5	Surtido 3 colores Assortment 3 colours	8421196119116



# Artículos de apoyo al Punto de Venta

## Display Stands

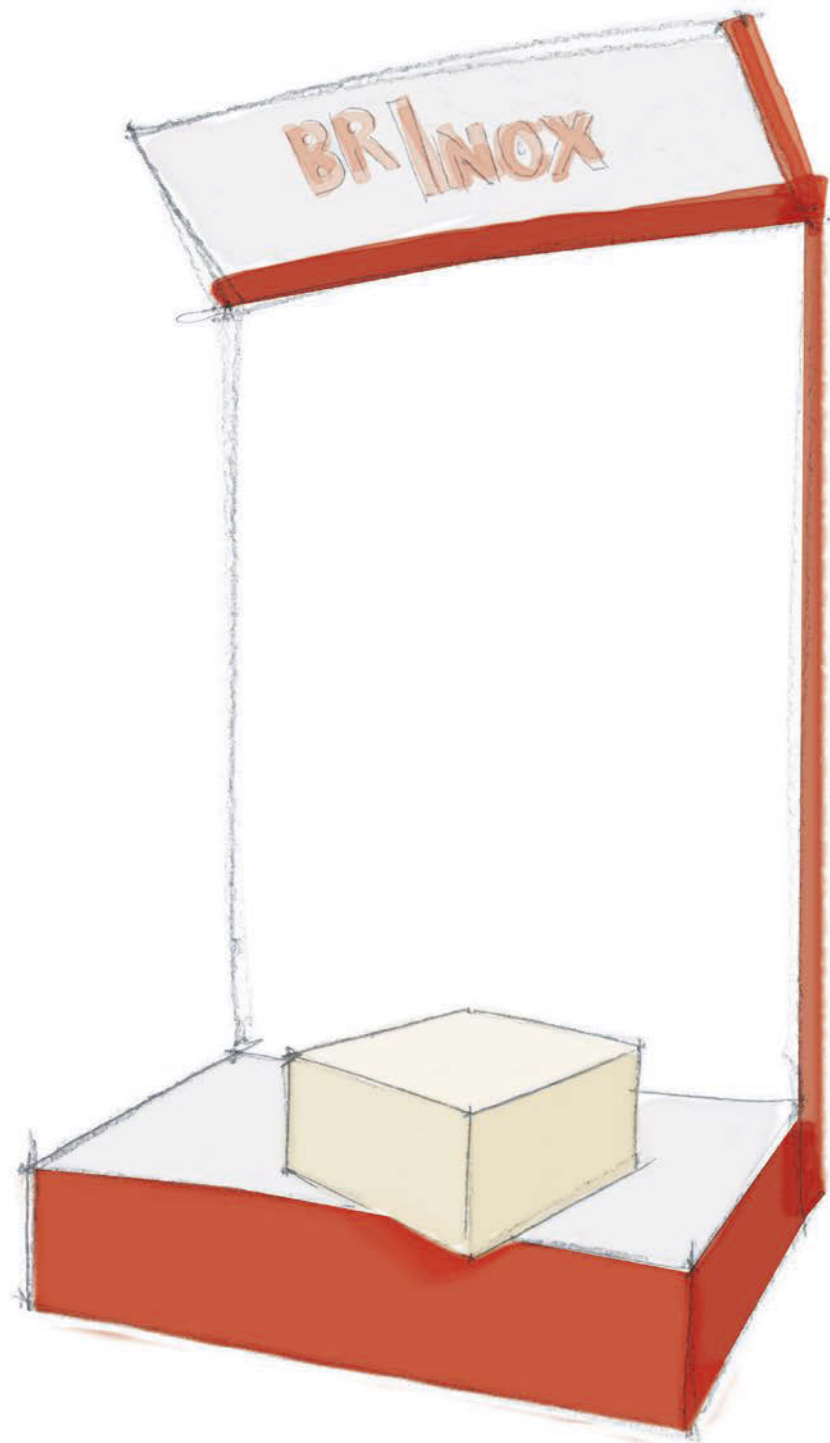



**Expositor para Tiras**  
*Exhibitor for strips*



Ref.	Ganchos Hooks	Alto Height	Ancho Width	Profundidad Depth
BQ011	14	148	97	40

**Expositor Doble para Tiras**  
*Double Exhibitor for strips*



Ref.	Ganchos Hooks	Alto Height	Ancho Width	Profundidad Depth
BQ016	28	175	97	60

**Expositor para Canal**  
*Exhibitor for Cable Trunking*



Ref.	Alto Height	Ancho Width	Profundidad Depth
BQ012	222	77	44

**Expositor Pequeño**  
*Small Exhibitor*



Ref.	Ganchos Hooks	Alto Height	Ancho Width	Profundidad Depth
BQ027	30	160	35	30

**Expositor General**  
*General Exhibitor*

Ref.	Ganchos Hooks	Alto Height	Ancho Width	Profundidad Depth
BQ014	60	230	100	40

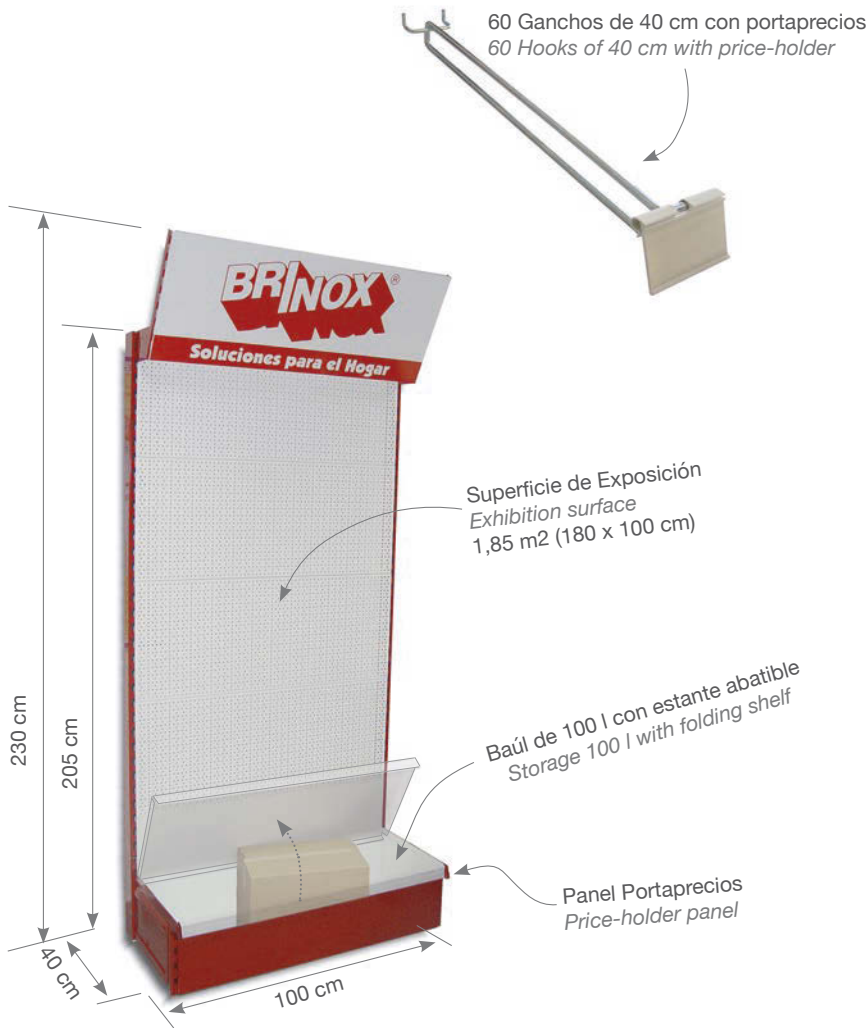

**Tira Expositor plástico**

Ref. BQ015  
Tira conocida como espina de pez  
para 10 blisters.

**Plastic Clip Strip**

Item No. BQ015  
10 blisters holder strip.



<b>B2</b>	B4271 ...161	B5100 ...35	B6106 ...154	B7002 ...165	B7058 ...86
B2001 ...62	B4272 ...161	B5101 ...35	B6107 ...120	B7003 ...166	B7059 ...95
B2002 ...62	B4273 ...161	B5110 ...125	B6108 ...120	B7004 ...166	B7060 ...150
B2011 ...63	B4274 ...161	B5201 ...12	B6109 ...120	B7005 ...79	B7061 ...150
B2012 ...63	B4280 ...160	B5203 ...13	B6110 ...123	B7006 ...79	B7062 ...148
B2041 ...64	B4281 ...160	B5204 ...12	B6111 ...123	B7007 ...80	B7063 ...148
B2042 ...64	B4400 ...167	B5300 ...42	B6112 ...123	B7008 ...66	B7064 ...39
B2051 ...62	B4401 ...167	B5301 ...42	B6114 ...122	B7009 ...74	B7065 ...40
<b>B3</b>	B4402 ...167	B5310 ...38	B6120 ...125	B7011 ...66	B7066 ...41
B3006 ...165	<b>B5</b>	B5311 ...39	B6121 ...126	B7012 ...74	B7067 ...21
B3016 ...9	B5001 ...28	<b>B6</b>	B6122 ...126	B7013 ...81	B7070 ...129
B3020 ...8	B5002 ...28	B6014 ...144	B6130 ...142	B7014 ...81	B7071 ...128
B3026 ...9	B5003 ...28	B6016 ...144	B6131 ...143	B7015 ...36	B7072 ...129
B3027 ...8	B5004 ...31	B6017 ...144	B6132 ...143	B7017 ...165	B7073 ...128
B3030 ...10	B5005 ...31	B6020 ...124	B6133 ...143	B7018 ...24	B7074 ...129
B3031 ...10	B5006 ...30	B6026 ...116	B6140 ...120	B7020 ...164	B7075 ...128
B3032 ...10	B5007 ...159	B6030 ...156	B6143 ...124	B7021 ...84	B7076 ...129
B3043 ...9	B5008 ...28	B6031 ...156	B6151 ...154	B7022 ...84	B7077 ...128
B3100 ...22	B5009 ...164	B6032 ...157	B6153 ...154	B7023 ...89	B7080 ...128
B3101 ...22	B5010 ...164	B6033 ...156	B6170 ...122	B7024 ...89	B7081 ...129
B3120 ...9	B5011 ...158	B6034 ...157	B6200 ...118	B7025 ...24	B7082 ...128
B3246 ...19	B5012 ...159	B6035 ...157	B6201 ...118	B7026 ...25	B7083 ...128
<b>B4</b>	B5017 ...30	B6036 ...157	B6202 ...118	B7027 ...24	B7084 ...129
B4202 ...163	B5018 ...29	B6037 ...156	B6203 ...118	B7030 ...118	B7090 ...131
B4203 ...163	B5019 ...29	B6041 ...114	B6204 ...118	B7031 ...118	B7093 ...166
B4204 ...163	B5020 ...29	B6045 ...115	B6205 ...118	B7032 ...118	B7095 ...96
B4205 ...163	B5021 ...36	B6046 ...115	B6210 ...119	B7033 ...118	B7097 ...96
B4206 ...162	B5040 ...36	B6060 ...108	B6211 ...119	B7034 ...88	B7098 ...95
B4207 ...162	B5041 ...166	B6061 ...108	B6215 ...119	B7035 ...87	B7102 ...72
B4212 ...170	B5051 ...35	B6063 ...108	B6216 ...119	B7036 ...16	B7103 ...72
B4213 ...170	B5052 ...35	B6064 ...108	B6220 ...121	B7037 ...165	B7121 ...73
B4230 ...160	B5053 ...35	B6070 ...109	B6222 ...121	B7038 ...91	B7122 ...78
B4231 ...160	B5063 ...32	B6071 ...109	B6225 ...124	B7039 ...91	B7123 ...67
B4240 ...168	B5064 ...32	B6073 ...109	B6261 ...150	B7040 ...38	B7124 ...75
B4241 ...168	B5065 ...32	B6074 ...109	B6263 ...150	B7041 ...38	B7125 ...73
B4242 ...168	B5067 ...33	B6080 ...110	B6272 ...130	B7043 ...21	B7126 ...78
B4243 ...169	B5068 ...33	B6081 ...110	B6273 ...130	B7044 ...19	B7129 ...67
B4246 ...169	B5069 ...33	B6083 ...110	B6274 ...130	B7045 ...18	B7130 ...75
B4247 ...169	B5080 ...34	B6090 ...110	B6275 ...130	B7046 ...18	B7201 ...25
B4250 ...161	B5081 ...34	B6091 ...110	B6276 ...130	B7047 ...16	B7206 ...27
B4251 ...161	B5082 ...34	B6093 ...110	B6277 ...131	B7048 ...17	B7207 ...27
B4260 ...161	B5083 ...34	B6101 ...155	B6278 ...131	B7050 ...85	B7211 ...26
B4261 ...161	B5090 ...34	B6102 ...155	B6279 ...131	B7051 ...87	B7212 ...26
B4262 ...161	B5091 ...34	B6103 ...155	B6281 ...130	B7053 ...85	B7213 ...26
B4263 ...161	B5092 ...34	B6104 ...154	<b>B7</b>	B7054 ...90	B7214 ...26
B4270 ...161	B5095 ...34	B6105 ...154	B7001 ...90	B7057 ...86	B7220 ...14



B7221 ...14	B7525 ...137	B7603 ...132	B7810 ...152	B8042 ...113	B8252 ...105
B7222 ...14	B7526 ...137	B7604 ...132	B7812 ...152	B8044 ...113	B8255 ...106
B7223 ...15	B7527 ...137	B7605 ...132	B7817 ...152	B8045 ...113	B8260 ...152
B7224 ...15	B7528 ...137	B7606 ...132	B7822 ...56	B8046 ...113	B8265 ...104
B7241 ...22	B7529 ...137	B7607 ...132	B7823 ...56	B8051 ...112	B8266 ...104
B7242 ...20	B7530 ...137	B7608 ...132	B7826 ...59	B8055 ...113	B8270 ...103
B7243 ...20	B7531 ...137	B7611 ...133	B7827 ...57	B8062 ...112	B8272 ...103
B7244 ...20	B7532 ...137	B7612 ...133	B7828 ...58	B8063 ...112	B8402 ...113
B7247 ...15	B7533 ...137	B7613 ...133	B7829 ...58	B8067 ...113	B8407 ...112
B7253 ...88	B7534 ...137	B7614 ...133	B7830 ...60	B8068 ...113	<b>B9</b>
B7260 ...94	B7535 ...137	B7615 ...133	B7831 ...60	B8072 ...112	B9001 ...47
B7262 ...94	B7541 ...137	B7616 ...133	B7850 ...151	B8073 ...112	B9002 ...46
B7263 ...94	B7542 ...137	B7621 ...133	B7851 ...151	B8077 ...113	B9003 ...48
B7265 ...95	B7543 ...137	B7731 ...136	B7852 ...151	B8078 ...113	B9004 ...49
B7270 ...96	B7544 ...137	B7732 ...136	B7860 ...151	B8082 ...112	B9005 ...46
B7300 ...92	B7545 ...137	B7733 ...136	B7861 ...151	B8083 ...112	B9006 ...48
B7301 ...92	B7546 ...137	B7734 ...136	B7862 ...151	B8087 ...113	B9008 ...51
B7302 ...93	B7547 ...137	B7735 ...136	<b>B8</b>	B8088 ...113	B9009 ...46
B7304 ...93	B7548 ...137	B7741 ...136	B8000 ...165	B8092 ...112	B9010 ...52
B7305 ...93	B7549 ...137	B7750 ...134	B8001 ...165	B8093 ...112	B9011 ...52
B7450 ...139	B7550 ...137	B7751 ...134	B8003 ...80	B8097 ...113	B9012 ...50
B7451 ...139	B7551 ...137	B7752 ...134	B8004 ...68	B8098 ...113	B9013 ...50
B7452 ...139	B7552 ...137	B7753 ...134	B8005 ...76	B8101 ...73	B9014 ...51
B7453 ...139	B7561 ...138	B7754 ...134	B8006 ...80	B8102 ...78	B9015 ...44
B7454 ...139	B7562 ...138	B7760 ...134	B8007 ...68	B8103 ...69	B9017 ...53
B7455 ...139	B7563 ...138	B7761 ...134	B8008 ...76	B8104 ...77	B9018 ...53
B7456 ...139	B7564 ...138	B7762 ...134	B8009 ...82	B8105 ...73	B9019 ...53
B7457 ...139	B7565 ...138	B7770 ...134	B8010 ...82	B8106 ...78	B9020 ...44
B7458 ...139	B7566 ...138	B7771 ...134	B8013 ...112	B8109 ...69	B9021 ...47
B7459 ...139	B7567 ...138	B7775 ...135	B8015 ...112	B8110 ...77	B9022 ...53
B7460 ...139	B7568 ...138	B7780 ...135	B8016 ...112	B8113 ...69	B9023 ...53
B7461 ...139	B7569 ...138	B7781 ...135	B8017 ...79	B8114 ...77	B9024 ...53
B7462 ...139	B7570 ...138	B7782 ...136	B8018 ...79	B8115 ...70	B9025 ...45
B7463 ...139	B7582 ...138	B7783 ...136	B8020 ...98	B8116 ...70	B9026 ...45
B7467 ...139	B7583 ...138	B7784 ...136	B8021 ...98	B8117 ...71	B9027 ...45
B7470 ...140	B7584 ...138	B7786 ...136	B8027 ...102	B8118 ...71	B9028 ...45
B7471 ...140	B7585 ...138	B7787 ...136	B8028 ...102	B8119 ...71	B9051 ...54
B7472 ...140	B7586 ...138	B7790 ...146	B8029 ...106	B8124 ...71	B9052 ...54
B7475 ...140	B7587 ...138	B7795 ...147	B8031 ...106	B8125 ...77	B9053 ...54
B7476 ...140	B7588 ...138	B7797 ...147	B8032 ...101	B8220 ...99	
B7478 ...140	B7589 ...138	B7800 ...149	B8033 ...101	B8221 ...99	
B7479 ...140	B7590 ...138	B7801 ...149	B8035 ...100	B8222 ...104	
B7521 ...137	B7591 ...138	B7802 ...148	B8036 ...112	B8245 ...105	
B7522 ...137	B7592 ...138	B7803 ...148	B8037 ...112	B8246 ...105	
B7523 ...137	B7593 ...138	B7804 ...149	B8038 ...112	B8250 ...105	
B7524 ...137	B7602 ...132	B7805 ...149	B8040 ...113	B8251 ...105	



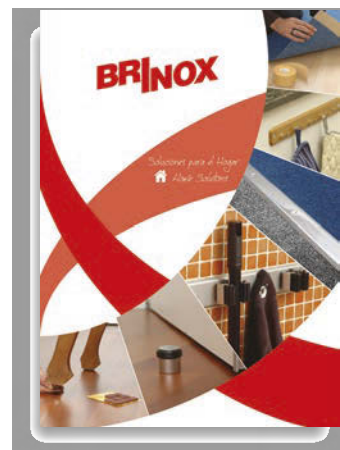
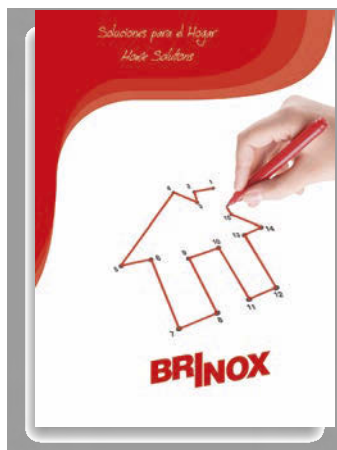
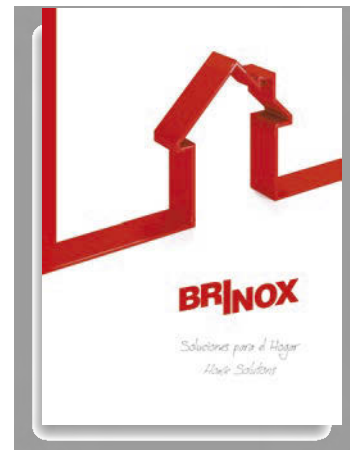
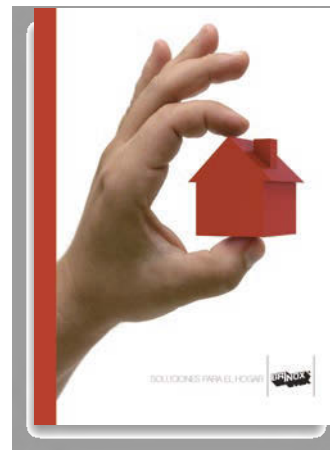
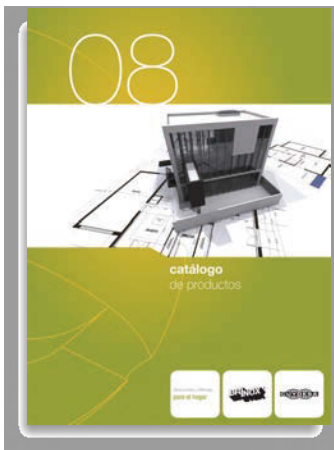
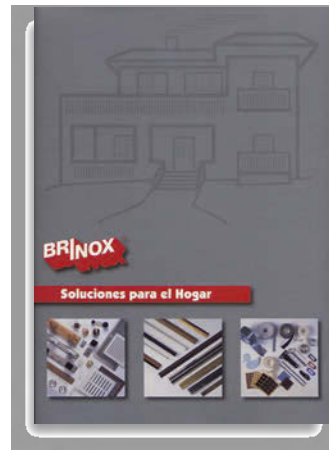
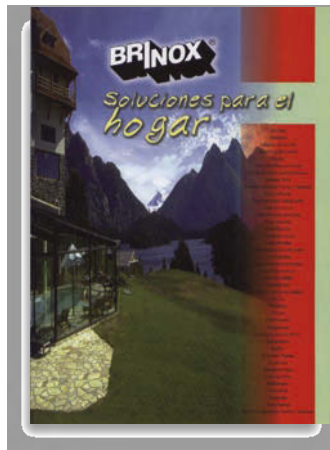

# BRINOX

**BRINOX, S.A.**

Avda. Pau Casals, 136-138  
08907 L'Hospitalet de Llobregat  
Barcelona (Spain)

Tel. (+34) 93 336 18 12  
Fax (+34) 93 335 76 30  
email: [info@brinox.com](mailto:info@brinox.com)

BRINOX, S.A. © Septiembre 2022





# BRINOX

Artículos de Ferrería  
DIY & Hardware  
[www.brinox.com](http://www.brinox.com)



Menaje para el hogar  
House & Kitchenware  
[www.cuydesa.com](http://www.cuydesa.com)

# BRIkids

Seguridad Infantil  
Kids safety  
[www.brikids.es](http://www.brikids.es)

# BRItools

Distribución Ferrerera  
DIY Distribution  
[www.britools.es](http://www.britools.es)



## BRINOX, S.A.

Avda. Pau Casals, 136-138  
08907 L'Hospitalet de Llobregat  
Barcelona (Spain)

Tel. (+34) 93 336 18 12  
Fax (+34) 93 335 76 30  
email: [info@brinox.com](mailto:info@brinox.com)

BRINOX, S.A. © Febrero 2024

